

where the world turns for couplings

Lovejoy[®]

Shaft Locking Devices

In This Section:

- Self-Centering Series SLDS
- Low Torque Series SLDS
- Medium Torque Series SLDS
- High Torque Series SLDS
- Heavy Duty Series SLDS

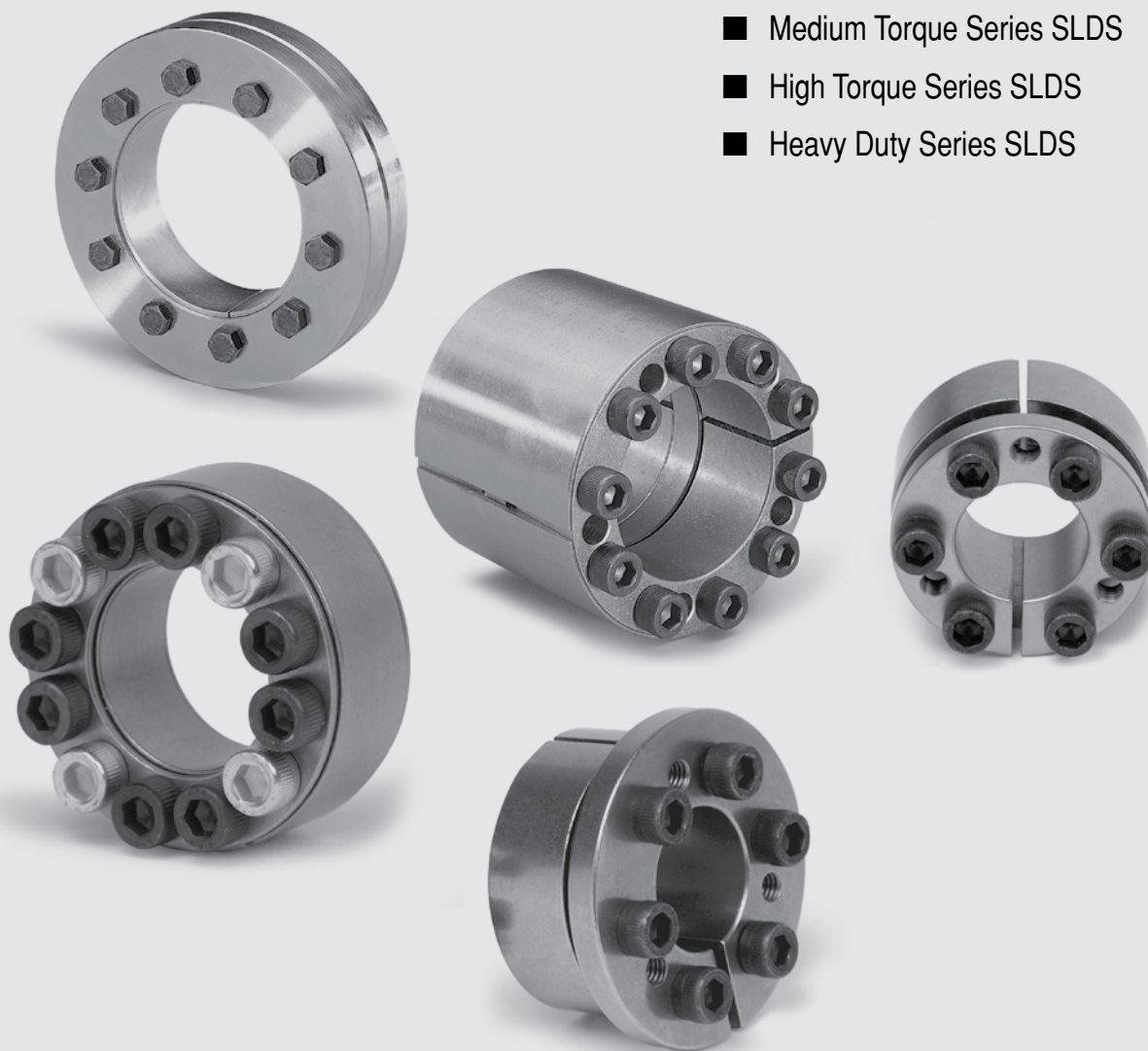

where the world turns for couplings

Lovejoy[®]

Shaft Locking Devices

Safety Warning

When using Lovejoy products, you must follow these instructions and take the following precautions. Failure to do so may cause the power transmission product to break and parts to be thrown with sufficient force to cause severe injury or death.

Refer to this Lovejoy Catalog for proper selection, sizing, horsepower, torque range, and speed range of power transmission products, including elastomeric elements for couplings. Follow the installation instructions included with the product, and in the individual product catalogs for proper installation of power transmission products. Do not exceed catalog ratings.

During start up and operation of power transmission product, avoid sudden shock loads. Coupling assembly should operate quietly and smoothly. If coupling assembly vibrates or makes beating sound, shut down immediately, and recheck alignment. Shortly after initial operation and periodically thereafter, where applicable, inspect coupling assembly for: alignment, wear of elastomeric element, bolt torques, and flexing elements for signs of fatigue. Do not operate coupling assembly if alignment is improper, or where applicable, if elastomeric element is damaged, or worn to less than 75% of its original thickness.

Do not use any of these power transmission products for elevators, man lifts, or other devices that carry people. If the power transmission product fails, the lift device could fall resulting in severe injury or death.

For all power transmission products, you must install suitable guards in accordance with OSHA and American Society of Mechanical Engineers Standards. Do not start power transmission product before suitable guards are in place. Failure to properly guard these products may result in severe injury or death from personnel contacting moving parts or from parts being thrown from assembly in the event the power transmission product fails.

If you have any questions, contact the Lovejoy Engineering Department at 1-630-852-0500.

where the world turns for couplings



Shaft Locking Devices

Table of Contents

	Running Page No.	Section Page No.
Overview.....	428	SLD-4
Applications / SLD 900 Series > Selection Data	430	SLD-6
Hub Sizing > Selection Process	431	SLD-7
Selection Process.....	432	SLD-8
SLD 900 Series > Dimensional Data.....	433	SLD-9
SLD 1500 Inch Series > Dimensional Data	434	SLD-10
SLD 1500 Metric Series > Dimensional Data	435	SLD-11
SLD 1850 Inch Series > Dimensional Data	436	SLD-12
SLD 1850 Metric Series > Dimensional Data	437	SLD-13
SLD 1750 Inch Series > Dimensional Data	438	SLD-14
SLD 1750 Metric Series > Dimensional Data	439	SLD-15
SLD 1350 Inch Series > Dimensional Data	440	SLD-16
SLD 1350 Metric Series > Dimensional Data	441	SLD-17
SLD 1450 Inch Series > Dimensional Data	442	SLD-18
SLD 1450 Metric Series > Dimensional Data	443	SLD-19
SLD 2600 Inch Series > Dimensional Data	444	SLD-20
SLD 2600 Metric Series > Dimensional Data	445	SLD-21
SLD 1900 Inch Series > Dimensional Data	446	SLD-22
SLD 1900 Metric Series > Dimensional Data	447	SLD-23
SLD 350 Series > Dimensional Data.....	448	SLD-24

SLD

Overview

Lovejoy Shaft Locking Devices connect hubs solidly to shafts, using a keyless mechanical interference fit, to transmit torque or to withstand axial thrust. This mechanical interference fit utilizes screw tension in the Shaft Locking Device, converted into radial pressure via an inclined plane. This pressure expands the Shaft Locking Device to eliminate the gap between the hub and the shaft. The Shaft Locking Device uses the friction bond between the Shaft Locking Device and the shaft/hub to create a zero backlash connection. This connection is easily releasable to remove the mechanical interference fit.

Lovejoy Shaft Locking Devices expand to fill the gap between the shaft and hub, allowing for easy installation and removal, saving time over traditional interference fit techniques. The contact pressures created using a Shaft Locking Device can be greater than traditional interference fit pressures, allowing for more torque to be transmitted or shorter hubs to be used. The easy installation also allows the hub to be positioned more accurately on the shaft, and can facilitate angular timing of the hub.

Features

Versus Traditional Keyed Connections

- No Backlash due to fit tolerances
- No impact effect from reversing loads
- Ability to adjust axial position and angular timing
- No fretting corrosion due to movement at the fit interface

Versus Traditional Interference Fits

- Easier and quicker to install
- Higher contact pressures can transmit greater torques
- Easy and quick to remove without damaging the shaft or hub - even after years of service

Design Benefits

- Eliminate cost of machining keyways or splines
- Reduce the shaft stress by removing keyways or splines
- Eliminating keyways often allows the use of a smaller diameter shaft
- Can place anywhere on shaft, and allows for easy angular timing
- Easy removal without damaging the shaft or hub means easier maintenance for your customer

Lovejoy SLD offers several types of Shaft Locking Devices, designed to be used in just about any application where a shaft connects to a hub.



WARNING

You must refer to page SLD-2 (Page 426) for Important Safety Instructions and Precautions for the selection and use of these products. Failure to follow the instructions and precautions can result in severe injury or death.

External Shaft Locking Device



SLD 900

- Self-centering
- Exceptional concentricity
- Suitable for hollow shafts
- Axial hub position fixed during clamping
- Recommended for hollow shafts



Metric 14mm to 240mm
 Larger sizes on request
 22 - 118,010 ft-lb

Internal Shaft Locking Device



SLD 1500

- Medium high torque
- Self releasing
- Not self-centering
- Axial hub position fixed during clamping



Metric shafts 17mm to 400mm
 Inch shafts 3/4 to 7-15/16 inch
 Larger sizes on request
 170 - 565,563 ft-lb



SLD 1850

- High torque
- Exceptional concentricity
- Self-centering
- Axial hub position can move during clamping



Metric shafts 18mm to 200mm
 Inch shafts 3/4 to 4 inch
 Larger sizes on request
 273 - 44,625 ft-lb



SLD 1750

- High torque
- Exceptional concentricity
- Self-centering
- Axial hub position fixed during clamping



Metric shafts 18mm to 200mm
 Inch shafts 3/4 to 4 inch
 Larger sizes on request
 214 - 35,948 ft-lb



SLD 1350

- High torque
- Exceptional concentricity
- Self-centering
- Axial hub position can move during clamping



Metric shafts 18mm to 200mm
 Inch shafts 3/4 to 4 inch
 Larger sizes on request
 259 - 40,274 ft-lb



SLD 1450

- High torque
- Exceptional concentricity
- Self-centering
- Axial hub position fixed during clamping



Metric shafts 18mm to 200mm
 Inch shafts 3/4 to 4 inch
 Larger sizes on request
 203 - 34,151 ft-lb



SLD 2600

- Heavy duty
- Very high torque
- Self-centering
- Exceptional concentricity



Metric shafts 25mm to 240mm
 Inch shafts 1 to 6-1/2 inch
 Larger sizes on request
 532 - 155,461 ft-lb



SLD 1900

- Medium torque
- Allows smaller diameter hubs
- Exceptional concentricity
- Self-centering
- Axial hub position fixed during clamping



Metric shafts 6mm to 130mm
 Inch shafts 3/4 to 2-15/16 inch
 Larger sizes on request
 10 - 18,618 ft-lb



SLD 350

- Low torque
- Small radial dimensions
- Can be combined for greater torque capacity

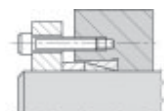

Metric shafts 6mm to 150mm
 Also available with cut ring
 Larger sizes on request
 1.73 - 9,104 ft-lb

SLD



Shaft Locking Devices

Applications / SLD 900 Series

Selection Process

Applications

- | | | |
|---------------------------|--|---------------------------------|
| Bevel gears | Gearboxes, reducers, and gear motors | Pump impellers & turbine rotors |
| Braiding machines | Graphic machines | Rolls |
| Brake drums | Helical gears | Section bar machines |
| Cardboard making machines | Industrial sewing machines | Shaker screens |
| Carpet making machines | Lamination machines | Sheaves |
| Chocolate making machines | Levers & cams | Ski lifts |
| Clutches | Meat & fish processing machines | Speed reducers |
| Compressors | Mechanical presses | Sprockets |
| Conveyor pulleys | Milk processing machines | Thermal pumps |
| Conveyors | Milling & drilling machines | Tobacco machines |
| Couplings | Mixer shafts | Vegetable-oil refining machines |
| Crushers | Moving sidewalks | Weaving machines |
| Fans | Packaging machines | Winches |
| Flanges | Pasta machines | Wind generators |
| Flywheels | Printing machines | Worm gears |
| Footwear machines | Pulp industry: drive rolls & cylinders | |

Steps In Selecting A 900 Series SLD



Step 1: Determine the shaft diameter to be used, or the maximum torque to be transmitted.

- Step 2:**
- If shaft diameter is the primary consideration, verify that the maximum torque to be transmitted is less than the maximum number listed.
 - If Torque is the primary consideration, use the table to determine the shaft size.

Torque range:

The maximum torque transmission for shaft diameter between those listed can be approximated using the following formula:

$$T_a = \left[\frac{S_a - S_{min}}{S_{max} - S_{min}} \right] \times \left[T_{max} - T_{min} \right] + T_{min}$$

Where:

S_a	= actual shaft size (in)	T_a	= actual torque
S_{min}	= minimum shaft size listed (in)	T_{min}	= minimum torque listed
S_{max}	= maximum shaft size listed (in)	T_{max}	= maximum torque listed

Minimum Outer Diameter of Hub

The hub must be of a size to withstand the pressure exerted by the Shaft Locking Device without yielding. Use the following equations to determine the minimum hub diameter (Dmin) required.

$$D_{min} = D \times K, \quad \text{where} \quad K = \sqrt{\frac{Y_p + (f \times p_H)}{Y_p - (f \times p_H)}}$$

- Where:
- D = Hub bore (inches)
 - Yp = Yield point of hub material (psi)
 - f = Form factor (see figure 1.)
 - pH = Contact pressure on the hub (psi)

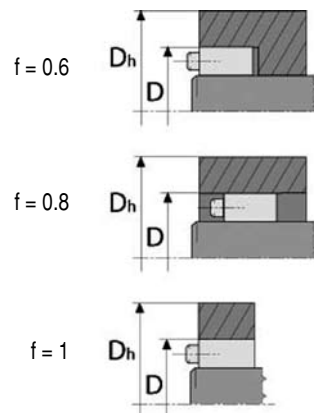

Figure 1

Alternatively, use the table below to determine the Coefficient K.

To use the table, find the column corresponding to the Yield Point of the hub material (in psi), and the Form factor "f" from above (based on the hub's length through bore). Use the row with the pH from the specification table for the Shaft Locking Device model you have selected rounded up to the nearest 1,000 psi. Multiply this K factor by the Hub Bore "D" (in inches) to calculate the minimum required hub OD.

Hub Material Yield Point

		32,000			45,000			90,000		
f =		1.00	0.80	0.60	1.00	0.80	0.60	1.00	0.80	0.60
7,000		1.25	1.19	1.14	1.17	1.13	1.10	1.08	1.06	1.05
8,000		1.29	1.22	1.16	1.20	1.15	1.11	1.09	1.07	1.05
9,000		1.34	1.26	1.19	1.22	1.18	1.13	1.11	1.08	1.06
10,000		1.38	1.29	1.21	1.25	1.20	1.14	1.12	1.09	1.07
11,000		1.43	1.33	1.23	1.28	1.22	1.16	1.13	1.10	1.08
12,000		1.48	1.36	1.26	1.31	1.24	1.18	1.14	1.11	1.08
13,000		1.54	1.40	1.28	1.35	1.27	1.19	1.16	1.12	1.09
14,000		1.60	1.44	1.31	1.38	1.29	1.21	1.17	1.13	1.10
15,000		1.66	1.48	1.34	1.41	1.31	1.22	1.18	1.14	1.11
16,000		1.73	1.53	1.36	1.45	1.34	1.24	1.20	1.15	1.11
17,000		1.81	1.57	1.39	1.49	1.37	1.26	1.21	1.16	1.12
18,000		1.89	1.62	1.42	1.53	1.39	1.28	1.22	1.18	1.13
19,000		1.98	1.68	1.45	1.57	1.42	1.30	1.24	1.19	1.14
20,000		2.08	1.73	1.48	1.61	1.45	1.31	1.25	1.20	1.14
21,000		2.20	1.79	1.52	1.66	1.48	1.33	1.27	1.21	1.15
22,000		2.32	1.86	1.55	1.71	1.51	1.35	1.28	1.22	1.16
23,000		2.47	1.93	1.59	1.76	1.54	1.37	1.30	1.23	1.17
24,000		2.65	2.00	1.62	1.81	1.58	1.39	1.31	1.24	1.18
25,000		2.85	2.08	1.66	1.87	1.61	1.41	1.33	1.25	1.18
26,000		3.11	2.17	1.70	1.93	1.65	1.44	1.35	1.27	1.19
27,000		3.44	2.27	1.75	2.00	1.69	1.46	1.36	1.28	1.20
28,000		3.87	2.38	1.79	2.07	1.73	1.48	1.38	1.29	1.12

Combined Torque and Axial Loads

If an axial load is present, then the resulting torque that can be transmitted needs to be adjusted as follows:

$$M_t \text{ Result} = \sqrt{M_t^2 + \left[\frac{F \times d}{24} \right]^2}$$

Where: d = shaft diameter (inches)
 M_t = maximum torque for device (ft-lbs)
 F = force (lbf)

Coefficients of Friction and Surface Finish

Lovejoy SLD uses $\mu = 0.12$ which corresponds to a slightly oiled surface
 $\sqrt[63]{\text{ }} = 63 \mu\text{IN RMS}$ for surface finish

Duty Factor

The values M_t and F must be adjusted with a duty factor depending on the setup:

Motor Type	Load		
	Constant	Light overloads	Heavy overloads
Electric	1.0	1.5	2.0
Combustion	1.5	2.0	2.5

Multiple Shaft Locking Devices Used in Series

If more than one Shaft Locking Device is used, the transmissible torque must be reduced by the following factors:

Shaft Locking Device	Number of devices in series		
	2	3	4
SLD 1500	0.80	0.75	0.70
SLD 1850	0.80	0.75	0.70
SLD 1350	0.80	0.75	0.70
SLD 2600	0.85	Not recommended	

Competitive Cross Reference



Lovejoy® Ringfeder® B-LOC	SLD 1500 RfN 7012 B400	SLD 900 RfN 4071 SD 10	SLD 1850 RfN 7013.0	SLD 1750 RfN 7013.1	SLD 1350 Rfc 303 B103	SLD 1450 Rfc 306 B106	SLD 1900 RfN 7110 B800	SLD 2600 TAS 3012 B112	SLD 350 RfN 8006 B500
---------------------------------	------------------------------	------------------------------	------------------------	------------------------	-----------------------------	-----------------------------	------------------------------	------------------------------	-----------------------------

L	= total width of thrust rings (relaxed state)
B	= width of thrust rings (relaxed state)
T	= locking screw specifications
M _A	= screw tightening torque
e	= width of gap (relaxed state)
ℓ	= length of contact
D	= outer diameter of disc
d	= hub OD diameter
d _s	= shaft diameter
C	= maximum diametrical clearance (difference between hub diameter and shaft diameter)
M _t	= maximum transmissible torque
T ₃	= tolerance of hub OD

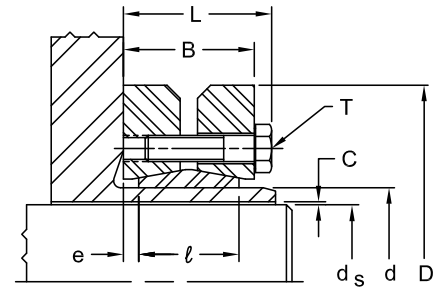

SLD 900 Series Dimensional Data

Size	d in	T ₃ in	d _s in	D in	L in	B in	ℓ in	e in	C in	Max M _t ft-lb	T Locking Screws			Weight lb	
											Qty	Size	M _A ft-lb		
14	0.551	+0 - 0.0013	0.433	1.496	0.591	0.433	0.354	0.039	0.001	22	4	M5	3	0.33	
			0.472												
16	0.630			0.551	1.614	0.728	0.591	0.433	0.079	0.001	66	5	M5	3	0.44
			0.551												
20	0.787			0.728	1.969	0.906	0.748	0.551	0.098	0.001	156	6	M5	3	0.44
			0.728												
24	0.945		0.866	1.969	0.906	0.748	0.551	0.098	0.001	210	6	M5	3	0.44	
		0.866													
30	1.181		1.063	2.362	0.984	0.827	0.630	0.098	0.001	306	6	M5	3	0.66	
		1.063													
36	1.417	+0 - 0.0015	1.063	2.835	1.063	0.906	0.709	0.098	0.001	465	5	M6	9	0.99	
			1.220												
44	1.732			1.250	3.150	1.142	0.984	0.787	0.098	0.001	719	7	M6	9	1.32
			1.496												
50	1.969		1.496	3.543	1.220	1.063	0.866	0.098	0.001	959	8	M6	9	1.76	
		1.654													
55	2.165	+0 - 0.0018	1.890	3.937	1.339	1.181	0.906	0.138	0.001	1401	8	M6	6	2.43	
			1.890												
62	2.441			2.047	4.331	1.339	1.181	0.906	0.138	0.001	1770	10	M6	9	2.87
			1.969												
68	2.677			2.362	4.528	1.339	1.181	0.906	0.138	0.001	2286	10	M6	9	3.09
			2.165												
75	2.953		2.559	5.433	1.496	1.299	0.984	0.157	0.002	2876	7	M8	22	3.75	
		2.362													
80	3.150		2.756	5.709	1.496	1.260	0.984	0.138	0.002	3393	7	M8	22	4.85	
		2.559													
90	3.543	+0 - 0.0021	2.953	6.102	1.772	1.535	1.181	0.177	0.002	5310	10	M8	22	7.28	
			2.756												
100	3.937			3.150	6.693	1.949	1.732	1.339	0.197	0.002	6638	12	M8	22	10.14
			2.953												
110	4.331			3.346	7.283	2.244	1.969	1.535	0.217	0.002	8113	9	M10	44	13.01
			3.150												
115	4.528		3.543	7.402	2.244	1.969	1.535	0.217	0.002	8851	9	M10	44	13.89	
		3.346													
125	4.921		3.740	8.465	2.402	2.123	1.654	0.236	0.002	11063	12	M10	44	18.96	
		3.543													
130	5.118	+0 - 0.0025	3.937	8.465	2.323	2.047	1.654	0.197	0.002	13424	12	M10	44	18.08	
			3.740												
140	5.512			4.134	9.055	2.677	2.362	1.811	0.276	0.002	14751	10	M12	74	22.05
			4.134												
155	6.102			4.528	10.433	2.756	2.441	1.969	0.236	0.003	19177	12	M12	74	33.07
			4.528												
165	6.496		4.921	11.417	3.071	2.677	2.205	0.236	0.003	32453	8	M16	184	48.50	
		4.921													
175	6.890		5.315	11.811	3.071	2.677	2.205	0.236	0.003	36141	8	M16	184	50.71	
		5.315													
185	7.283	+0 - 0.0028	5.709	12.992	3.780	3.386	2.795	0.295	0.003	47942	10	M16	184	79.37	
			5.512												
195	7.677			6.102	13.780	3.780	3.386	2.795	0.295	0.003	60480	12	M16	184	88.18
			5.906												
200	7.874			6.299	13.780	3.780	3.386	2.795	0.295	0.003	65643	12	M16	184	105.82
			6.299												
220	8.661		6.693	14.567	4.488	4.094	3.465	0.315	0.003	81132	15	M16	184	119.05	
		6.693													
240	9.449		7.480	15.945	4.803	4.291	3.622	0.335	0.003	118010	12	M20	361	147.71	

Shaft Locking Devices

SLD 1500 Inch Series

Dimensional Data

- L = total width (relaxed state)
- B = width of thrust rings (relaxed state)
- ℓ = length of contact
- T = locking screw specifications
- M_A = screw tightening torque
- D = outer diameter of shaft locking device
- d = shaft diameter
- F = maximum transmissible axial force
- M_t = maximum transmissible torque
- pH = pressure on the hub
- pS = pressure on the shaft
- T₁ = tolerance of shaft
- T₂ = tolerance of hub bore

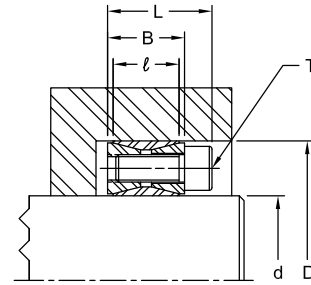

SLD 1500 Inch Series Dimensional Data

Size	d in	T ₁ in	D in	T ₂ in	B in	ℓ in	L in	Max F lbf	Max M _t ft-lb	Pressures		Locking Screws				
										pH psi	pS psi	Qty	Size	M _A ft-lb		
3/4	0.750	+0 -0.0013	1.850	-0 +0.002	0.787	0.669	1.023	6,208	194	13,293	32,789	8	M6	11		
7/8	0.088		1.850		0.787	0.669	1.023	6,199	226	13,293	28,105	8	M6	11		
1	1.000	+0 -0.0025	1.969	-0 +0.0025	0.787	0.669	1.023	6,192	258	12,490	24,592	8	M6	11		
1-1/8	1.125		2.165		0.787	0.669	1.023	9,301	436	17,038	32,789	12	M6	11		
1-3/16	1.188		2.159		0.813	0.669	1.049	9,297	460	17,086	31,064	12	M6	11		
1-1/4	1.250		2.362		0.787	0.669	1.023	9,312	485	15,617	29,511	12	M6	11		
1-3/8	1.375		2.365		0.787	0.669	1.023	9,303	533	15,598	26,828	12	M6	11		
1-7/16	1.438		2.559		0.787	0.669	1.023	11,637	697	18,019	32,077	15	M6	11		
1-1/2	1.500		2.559		0.787	0.669	1.023	11,632	727	18,019	30,740	15	M6	11		
1-5/8	1.625		2.953		0.945	0.787	1.260	17,516	1,186	19,993	36,331	12	M8	27		
1-11/16	1.688		2.953		0.945	0.787	1.260	17,522	1,232	19,993	34,986	12	M8	27		
1-3/4	1.750		2.953		0.945	0.787	1.260	17,513	1,277	19,993	33,736	12	M8	27		
1-7/8	1.875		3.150		0.945	0.787	1.260	17,510	1,368	18,742	31,487	12	M8	27		
1-15/16	1.938		3.150		0.945	0.787	1.260	16,487	1,331	17,640	28,679	12	M8	27		
2	2.000		3.346		0.945	0.787	1.260	20,604	1,717	20,758	34,728	15	M8	27		
2-1/8	2.125		+0 -0.0030		3.346	-0 +0.0033	0.945	0.787	1.260	20,612	1,825	20,758	32,686	15	M8	27
2-3/16	2.188				3.543		0.945	0.787	1.260	20,604	1,878	19,604	31,752	15	M8	27
2-1/4	2.250				3.543		0.945	0.787	1.260	20,608	1,932	19,604	30,870	15	M8	27
2-3/8	2.375	3.531		0.945	0.787		1.260	20,605	2,039	19,671	29,245	15	M8	27		
2-7/16	2.438	3.740		0.945	0.787		1.260	20,608	2,093	18,571	28,495	15	M8	27		
2-1/2	2.500	3.740		0.945	0.787		1.260	20,611	2,147	18,571	27,783	15	M8	27		
2-9/16	2.563	3.737		0.945	0.787		1.260	20,605	2,200	18,586	27,105	15	M8	27		
2-5/8	2.625	4.331		1.102	0.945		1.496	31,122	3,404	20,169	33,276	15	M10	52		
2-11/16	2.688	4.331		1.102	0.945		1.496	31,122	3,485	20,169	32,503	15	M10	52		
2-3/4	2.750	4.337		1.102	0.945		1.496	31,121	3,566	20,141	31,764	15	M10	52		
2-7/8	2.875	4.528		1.102	0.945		1.496	31,121	3,728	19,291	30,383	15	M10	52		
2-15/16	2.938	4.724		1.102	0.945		1.496	31,120	3,809	19,291	29,736	15	M10	52		
3	3.000	4.724		1.102	0.945		1.496	31,120	3,890	18,491	29,117	15	M10	52		
3-1/8	3.125	+0 -0.0035		4.921	-0 +0.0035		1.102	0.945	1.496	31,119	4,052	18,491	27,952	15	M10	52
3-1/4	3.250			4.921			1.102	0.945	1.496	31,119	4,214	17,751	26,877	15	M10	52
3-3/8	3.375			5.118			1.102	0.945	1.496	31,118	4,376	17,751	25,882	15	M10	52
3-7/16	3.438		5.118	1.102		0.945	1.496	31,118	4,457	17,067	25,411	15	M10	52		
3-1/2	3.500		5.305	1.102		0.945	1.496	31,118	4,538	17,067	24,957	15	M10	52		
3-3/4	3.750		5.709	1.102		0.945	1.496	37,344	5,835	19,759	27,952	18	M10	52		
3-7/8	3.875		5.709	1.260		1.024	1.732	45,560	7,356	20,676	30,456	15	M12	91		
3-15/16	3.938		5.843	1.260		1.024	1.732	46,068	7,558	20,906	30,306	15	M12	91		
4	4.000		6.102	1.260		1.024	1.732	46,062	7,677	20,423	29,833	15	M12	91		
4-3/16	4.188		6.496	1.260		1.024	1.732	46,063	8,037	19,556	28,497	15	M12	91		
4-7/16	4.438		6.496	1.260		1.024	1.732	49,136	9,085	19,594	28,684	16	M12	91		
4-1/2	4.500		7.087	1.260		1.024	1.771	49,136	9,213	19,594	28,286	16	M12	91		
4-15/16	4.938		+0 -0.0040	7.087		-0 +0.0040	1.496	1.339	1.968	61,421	12,636	17,169	24,643	20	M12	91
5	5.000			7.480			1.496	1.339	1.968	61,421	12,796	17,169	24,335	20	M12	91
5-7/16	5.438			7.492			1.496	1.339	1.968	67,562	15,307	17,894	24,615	22	M12	91
5-1/2	5.500			8.268			1.496	1.339	1.968	67,562	15,483	17,865	24,335	22	M12	91
6	6.000	8.858		1.496	1.339		1.968	79,844	19,961	19,132	26,363	26	M12	91		
6-7/16	6.438	8.858		1.732	1.496		2.283	86,683	23,251	17,352	23,877	22	M14	138		
6-1/2	6.500	9.252		1.732	1.496		2.283	86,684	23,477	17,352	23,647	22	M14	138		
6-15/16	6.938	9.252		1.732	1.496		2.283	94,564	27,335	18,123	24,170	24	M14	138		
7	7.000	9.252		1.732	1.496		2.283	94,563	27,581	18,123	23,954	24	M14	138		
7-1/2	7.500	+0 -0.0045		9.823	-0 +0.0045		2.051	1.811	2.602	110,326	34,477	16,451	21,546	28	M14	138
7-7/8	7.875			10.235			2.051	1.811	2.602	118,205	38,786	16,917	21,986	30	M14	138
8	8.000			10.504			2.051	1.811	2.602	118,206	39,402	16,483	21,643	30	M14	138

SLD

- L = total width (relaxed state)
- B = width of thrust rings (relaxed state)
- ℓ = length of contact
- T = locking screw specifications
- M_A = screw tightening torque
- D = outer diameter of shaft locking device
- d = shaft diameter
- F = maximum transmissible axial force
- M_t = maximum transmissible torque
- pH = pressure on the hub
- pS = pressure on the shaft
- T₁ = tolerance of shaft
- T₂ = tolerance of hub bore

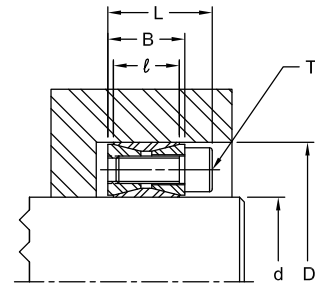

SLD 1500 Metric Series Dimensional Data

Size	d in	T ₁ in	D in	T ₂ in	B in	ℓ in	L in	Max F lbf	Max M _t ft-lb	Pressures		T Locking Screws		
										pH psi	pS psi	Qty	Size	M _A ft-lb
17x47	0.669	+0 -0.0013	1.850	-0 +0.002	0.787	0.669	1.024	6,083	170	13,343	36,985	8	M6	11.80
18x47	0.709		1.850		0.787	0.669	1.024	6,245	184	13,343	34,954	8	M6	11.80
19x47	0.748		1.850		0.787	0.669	1.024	6,153	192	13,343	33,069	8	M6	11.80
20x47	0.787		1.850		0.787	0.669	1.024	6,295	207	13,343	31,473	8	M6	11.80
22x47	0.866		1.850		0.787	0.669	1.024	6,336	229	13,343	28,572	8	M6	11.80
24x50	0.945		1.969		0.787	0.669	1.024	6,182	243	12,618	26,252	8	M6	11.80
25x50	0.984		1.969		0.787	0.669	1.024	6,295	258	12,618	25,237	8	M6	11.80
28x55	1.102		+0 -0.0025		2.165	-0 +0.0025	0.787	0.669	1.024	9,314	428	17,114	33,794	12
30x55	1.181	2.165		0.787	0.669		1.024	9,442	465	17,114	31,473	12	M6	11.80
32x60	1.260	2.362		0.787	0.669		1.024	9,414	494	15,954	29,443	12	M6	11.80
35x60	1.378	2.362		0.787	0.669		1.024	9,378	538	15,954	26,977	12	M6	11.80
38x65	1.496	2.559		0.787	0.669		1.024	11,714	730	18,130	31,038	15	M6	11.80
40x65	1.575	2.559		0.787	0.669		1.024	11,690	767	18,130	29,443	15	M6	11.80
42x75	1.654	2.953		0.945	0.787		1.260	17,128	1,180	20,305	34,809	12	M8	28.00
45x75	1.772	2.953		0.945	0.787		1.260	16,986	1,254	20,305	32,489	12	M8	28.00
48x80	1.890	3.150		0.945	0.787		1.260	16,861	1,328	17,405	30,458	12	M8	28.00
50x80	1.969	3.150		0.945	0.787		1.260	17,085	1,401	18,855	29,298	12	M8	28.00
55x85	2.165	3.346		0.945	0.787		1.260	21,255	1,918	21,756	33,214	15	M8	28.00
60x90	2.362	3.543		0.945	0.787		1.260	21,357	2,102	20,305	30,458	15	M8	28.00
65x95	2.559	3.740		0.945	0.787		1.260	21,443	2,286	18,855	28,137	15	M8	28.00
70x110	2.756	4.331		1.102	0.945		1.496	34,364	3,946	23,206	34,954	15	M10	55.00
75x115	2.953	4.528		1.102	0.945		1.496	34,351	4,226	21,756	32,634	15	M10	55.00
80x120	3.150	4.724		1.102	0.945		1.496	34,283	4,499	20,305	30,603	15	M10	55.00
85x125	3.346	4.921	1.102	0.945	1.496	34,383	4,794	20,305	28,863	15	M10	55.00		
90x130	3.543	5.118	1.102	0.945	1.496	34,471	5,089	18,855	27,267	18	M10	55.00		
95x135	3.740	5.315	1.102	0.945	1.496	41,176	6,417	21,756	30,893	18	M10	55.00		
100x145	3.937	5.709	1.260	1.024	1.732	50,357	8,261	23,206	33,214	15	M12	96.00		
110x155	4.331	6.102	1.260	1.024	1.732	50,275	9,072	21,756	30,168	15	M12	96.00		
120x165	4.724	6.496	1.260	1.024	1.732	53,579	10,547	21,756	29,443	16	M12	96.00		
130x180	5.118	7.087	1.496	1.339	1.969	67,097	14,309	18,855	25,962	20	M12	96.00		
140x190	5.512	7.480	1.496	1.339	1.969	73,866	16,964	20,305	26,542	22	M12	96.00		
150x200	5.906	7.874	1.496	1.339	1.969	80,631	19,840	20,305	26,977	24	M12	96.00		
160x210	6.299	8.268	1.496	1.339	1.969	87,113	22,864	21,756	27,412	26	M12	96.00		
170x225	6.693	8.858	1.732	1.496	2.283	96,007	26,774	20,305	25,527	22	M14	148.00		
180x235	7.087	9.252	1.732	1.496	2.283	104,911	30,978	20,305	26,252	24	M14	148.00		
190x250	7.480	9.843	2.047	1.811	2.598	122,580	38,206	18,855	23,931	28	M14	148.00		
220x260	7.874	10.236	2.047	1.811	2.598	131,064	43,000	18,855	24,366	30	M14	148.00		
220x285	8.661	11.220	2.205	1.969	2.835	151,439	54,653	18,855	23,641	26	M16	221.00		
240x305	9.449	12.008	2.205	1.969	2.835	174,602	68,741	20,305	24,947	30	M16	221.00		
260x325	10.236	12.795	2.205	1.969	2.835	198,005	84,451	21,756	26,107	34	M16	221.00		
280x355	11.024	13.976	2.598	2.362	3.307	226,415	103,996	18,855	23,061	32	M18	302.00		
300x375	11.811	14.764	2.598	2.362	3.307	254,783	125,386	20,305	24,221	36	M18	302.00		
320x405	12.598	15.945	3.071	2.835	3.858	330,891	173,696	20,305	24,511	36	M20	435.00		
340x425	13.386	16.732	3.071	2.835	3.858	330,601	184,391	18,855	23,206	36	M20	435.00		
360x455	14.173	17.913	3.543	3.307	4.409	410,901	242,658	18,855	23,206	36	M22	583.00		
380x475	14.961	18.701	3.543	3.307	4.409	409,862	255,492	17,405	22,046	36	M22	583.00		
400x495	15.748	19.488	3.543	3.307	4.409	410,276	269,210	17,405	20,885	36	M22	583.00		
420x515	16.535	20.276	3.543	3.307	4.409	455,399	313,759	17,405	22,046	40	M22	583.00		
440x545	17.323	21.457	4.016	3.780	4.961	626,808	452,421	20,305	25,382	40	M24	885.00		
460x565	18.110	22.244	4.016	3.780	4.961	626,826	472,999	18,855	24,366	40	M24	885.00		
480x585	18.898	23.031	4.016	3.780	4.961	658,222	518,285	20,305	24,511	42	M24	885.00		
500x605	19.685	23.819	4.016	3.780	4.961	689,534	565,563	20,305	24,656	44	M24	885.00		

SLD

- L = total width (relaxed state)
- B = width of thrust rings (relaxed state)
- ℓ = length of contact
- T = locking screw specifications
- M_A = screw tightening torque
- D_A = outer diameter of shaft locking device
- d = shaft diameter
- F = maximum transmissible axial force
- Mt = maximum transmissible torque
- pH = pressure on the hub
- pS = pressure on the shaft
- T₁ = tolerance of shaft
- T₂ = tolerance of hub bore

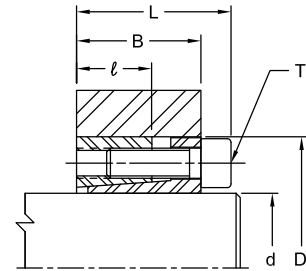

SLD 1850 Inch Series Dimensional Data

Size	d in	T ₁ in	D in	T ₂ in	B in	ℓ in	L in	Max F lbf	Max Mt ft-lb	Pressures		T Locking Screws		
										pH psi	pS psi	Qty	Size	M _A ft-lb
3/4	0.750	+0 -0.0013	1.850	-0 +0.0015	1.102	0.669	1.339	9,181	287	19,725	36,840	6	M6	10
7/8	0.875		1.850		1.102	0.669	1.339	9,104	332	19,725	31,763			
1	1.000	+0 -0.0016	1.969	-0 +0.0018	1.102	0.669	1.339	9,063	378	18,565	27,992	6	M6	10
1-1/8	1.125		2.165		1.102	0.669	1.339	9,346	438	16,824	24,076			
1-3/16	1.188		2.165		1.102	0.669	1.339	9,153	453	16,824	23,351			
1-1/4	1.250		2.362		1.102	0.669	1.339	12,377	645	20,595	29,153			
1-3/8	1.375		2.362		1.102	0.669	1.339	12,307	705	20,595	26,687			
1-7/16	1.438		2.559		1.102	0.669	1.339	12,437	745	19,000	25,237			
1-1/2	1.500		2.559		1.102	0.669	1.339	12,238	765	19,000	24,511			
1-5/8	1.625		2.953		1.299	0.787	1.614	23,377	1,583	26,832	36,405			
1-11/16	1.688		2.953		1.299	0.787	1.614	23,612	1,660	26,832	34,664			
1-3/4	1.750		2.953		1.299	0.787	1.614	23,295	1,699	26,832	33,939			
1-7/8	1.875	+0 -0.0018	3.150	-0 +0.0022	1.319	0.787	1.614	23,725	1,853	25,237	31,038	8	M8	26
1-15/16	1.938		3.150		1.319	0.787	1.614	23,434	1,892	25,237	30,458			
2	2.000		3.150		1.319	0.787	1.614	23,631	1,969	25,237	29,298			
2-1/8	2.125		3.346		1.319	0.787	1.614	23,549	2,085	23,641	27,557			
2-3/16	2.188		3.346		1.319	0.787	1.614	23,726	2,163	23,641	26,687			
2-1/4	2.250		3.543		1.319	0.787	1.614	23,476	2,201	22,336	26,107			
2-3/8	2.375		3.543		1.319	0.787	1.614	23,411	2,317	22,336	24,802			
2-7/16	2.438		3.740		1.319	0.787	1.614	23,573	2,394	21,176	24,076			
2-1/2	2.500		3.740		1.319	0.787	1.614	23,720	2,471	21,176	23,351			
2-9/16	2.563		3.740		1.319	0.787	1.614	23,508	2,510	21,176	22,916			
2-11/16	2.688	+0 -0.0022	4.331	-0 +0.0025	1.575	0.945	1.969	38,202	4,278	24,802	29,733	8	M10	52
2-3/4	2.750		4.331		1.575	0.945	1.969	38,435	4,404	24,802	29,008			
2-7/8	2.875		4.528		1.575	0.945	1.969	38,340	4,593	23,786	27,702			
2-15/16	2.938		4.528		1.575	0.945	1.969	38,549	4,718	23,786	26,977			
3	3.000		4.724		1.575	0.945	1.969	38,253	4,782	22,771	26,687			
3-1/4	3.250		4.921		1.575	0.945	1.969	48,203	6,527	27,412	30,458			
3-3/8	3.375		4.921		1.575	0.945	1.969	48,096	6,763	27,412	29,443			
3-7/16	3.438		5.118		1.575	0.945	1.969	47,767	6,842	26,252	29,153			
3-1/2	3.500		5.118		1.575	0.945	1.969	47,996	6,999	26,252	28,427			
3-3/4	3.750		5.315		1.575	0.945	1.969	47,813	7,471	25,382	26,687			
3-15/16	3.938	+0 -0.0022	5.709	-0 +0.0025	1.732	1.024	2.205	53,291	8,743	24,221	28,137	8	M12	85
4	4.000		5.709		1.732	1.024	2.205	53,507	8,918	24,221	27,557			

L	= total width (relaxed state)
B	= width of thrust rings (relaxed state)
ℓ	= length of contact
T	= locking screw specifications
M _A	= screw tightening torque
D	= outer diameter of shaft locking device
d	= shaft diameter
F	= maximum transmissible axial force
Mt	= maximum transmissible torque
pH	= pressure on the hub
pS	= pressure on the shaft
T ₁	= tolerance of shaft
T ₂	= tolerance of hub bore

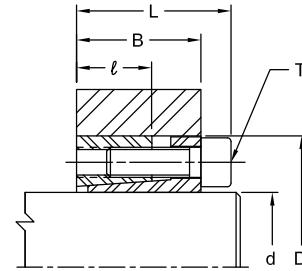

SLD 1850 Metric Series Dimensional Data

Size	d in	T ₁ in	D in	T ₂ in	B in	ℓ in	L in	Max F lbf	Max Mt ft-lb	Pressures		T Locking Screws				
										pH psi	pS psi	Qty	Size	M _A ft-lb		
18x47	0.709	+0 -0.0013	1.850	-0 +0.0015	1.102	0.669	1.339	9,242	273	19,725	38,870	6	M6	10		
19x47	0.748		1.850		1.102	0.669	1.339	9,253	288	19,725	36,840	6	M6	10		
20x47	0.787		1.850		1.102	0.669	1.339	9,217	302	19,725	34,954	6	M6	10		
22x47	0.866		1.850		1.102	0.669	1.339	9,197	332	19,725	31,763	6	M6	10		
24x50	0.945		1.969		1.102	0.669	1.339	9,198	362	18,565	29,153	6	M6	10		
25x50	0.984		1.969		1.102	0.669	1.339	9,208	378	18,565	27,992	6	M6	10		
28x55	1.102	+0 -0.0015	2.165	-0 +0.0018	1.102	0.669	1.339	9,201	423	16,824	24,947	6	M6	10		
30x55	1.181		2.165		1.102	0.669	1.339	9,202	453	16,824	23,351	6	M6	10		
32x60	1.260		2.362		1.102	0.669	1.339	12,280	645	20,595	29,153	8	M6	10		
35x60	1.378		2.362		1.102	0.669	1.339	12,281	705	20,595	26,687	8	M6	10		
38x65	1.496		2.559		1.102	0.669	1.339	12,270	765	19,000	24,511	8	M6	10		
40x65	1.575		2.559		1.102	0.669	1.339	12,275	805	19,000	23,351	8	M6	10		
42x75	1.654		2.953		1.299	0.787	1.614	23,541	1,622	26,832	32,343	8	M8	26		
45x75	1.772		2.953		1.299	0.787	1.614	23,540	1,738	26,832	33,214	8	M8	26		
48x80	1.890		3.150		1.319	0.787	1.614	23,539	1,853	25,237	31,038	8	M8	26		
50x80	1.969		3.150		1.319	0.787	1.614	23,533	1,930	25,237	29,878	8	M8	26		
55x85	2.165		+0 -0.0018		3.346	-0 +0.0021	1.319	0.787	1.614	23,535	2,123	23,641	27,122	8	M8	26
60x90	2.362				3.543		1.319	0.787	1.614	23,537	2,317	22,336	24,802	8	M8	26
65x95	2.559	3.740		1.319	0.787		1.614	23,539	2,510	21,176	22,916	8	M8	26		
70x110	2.756	4.331		1.575	0.945		1.969	38,352	4,404	24,802	29,008	8	M10	52		
75x115	2.953	4.528		1.575	0.945		1.969	38,349	4,718	23,786	26,977	8	M10	52		
80x120	3.150	4.724		1.575	0.945		1.969	38,352	5,033	22,771	25,382	8	M10	52		
85x125	3.346	+0 -0.0021		4.921	-0 +0.0025		1.575	0.945	1.969	47,940	6,685	27,412	29,733	10	M10	52
90x130	3.543			5.118			1.575	0.945	1.969	47,939	7,078	26,252	28,137	10	M10	52
95x135	3.740		5.315	1.575		0.945	1.969	47,939	7,471	25,382	26,687	10	M10	52		
100x145	3.937		5.709	1.732		1.024	2.205	53,298	8,743	24,221	28,137	8	M12	85		
110x155	4.331		6.102	1.732		1.024	2.205	53,296	9,617	22,626	23,061	8	M12	85		
120x165	4.724		6.496	1.732		1.024	2.205	59,960	11,803	23,931	23,786	9	M12	85		
130x180	5.118	+0 -0.0025	7.087	-0 +0.0028	2.047	1.339	2.205	79,946	17,049	22,336	24,366	12	M12	85		
140x190	5.512		7.480		2.126	1.339	2.677	81,609	18,742	21,611	22,191	9	M14	136		
150x200	5.906		7.874		2.126	1.339	2.677	90,676	22,312	22,771	23,061	10	M14	136		
160x210	6.299		8.268		2.126	1.339	2.677	108,813	28,560	26,107	25,817	12	M14	136		
170x225	6.693		8.858		2.520	1.732	3.071	108,813	30,345	18,855	20,305	12	M14	136		
180x235	7.087		9.252		2.520	1.732	3.071	108,813	32,130	17,985	19,145	12	M14	136		
190x250	7.480		9.843		2.520	1.732	3.071	136,016	42,394	21,176	22,626	15	M14	136		
200x260	7.874		10.236		2.520	1.732	3.071	136,016	44,625	20,305	21,611	15	M14	136		

Shaft Locking Devices

SLD 1750 Inch Series

Dimensional Data

- L = total width (relaxed state)
- B = width of thrust rings (relaxed state)
- A = width to flange
- ℓ = length of contact
- T = locking screw specifications
- M_A = screw tightening torque
- D = outer diameter of shaft locking device
- D₁ = diameter to flange
- d = shaft diameter
- F = maximum transmissible axial force
- Mt = maximum transmissible torque
- pH = pressure on the hub
- pS = pressure on the shaft
- T₁ = tolerance of shaft
- T₂ = tolerance of hub bore

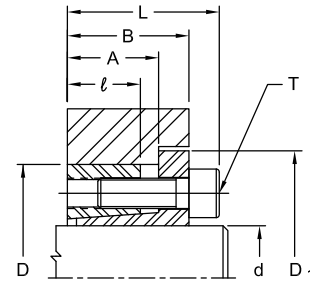

SLD 1750 Inch Series Dimensional Data

Size	d in	T ₁ in	D in	T ₂ in	D ₁ in	A in	B in	ℓ in	L in	Max F lbf	Max Mt ft-lb	Pressures		T Locking Screws		
												pH psi	pS psi	Qty	Size	M _A ft-lb
3/4	0.750	+0 -0.0013	1.850	-0 +0.0015	2.204	0.866	1.102	0.669	1.339	7,623	238	15,515	26,024	6	M6	13
7/8	0.875		1.850		2.204	0.866	1.102	0.669	1.339	7,623	278	15,515	22,306	6	M6	13
1	1.000	+0 -0.0016	1.969	-0 +0.0018	2.323	0.866	1.102	0.669	1.339	7,623	318	14,577	19,518	6	M6	13
1-1/8	1.125		2.165		2.519	0.866	1.102	0.669	1.339	7,623	357	13,258	17,349	6	M6	13
1-3/16	1.188		2.165		2.519	0.866	1.102	0.669	1.339	7,623	377	13,258	16,436	6	M6	13
1-1/4	1.250		2.362		2.716	0.866	1.102	0.669	1.339	10,164	529	16,202	20,819	8	M6	13
1-3/8	1.375		2.362		2.716	0.866	1.102	0.669	1.339	10,164	582	16,202	18,926	8	M6	13
1-7/16	1.438		2.559		2.913	0.866	1.102	0.669	1.339	10,164	609	14,955	18,103	8	M6	13
1-1/2	1.500		2.559		2.913	0.866	1.102	0.669	1.339	10,164	635	14,955	17,349	8	M6	13
1-5/8	1.625		2.953		3.307	0.984	1.299	0.787	1.614	18,806	1,273	20,381	24,691	8	M8	30
1-11/16	1.688		2.953		3.307	0.984	1.299	0.787	1.614	18,806	1,322	20,381	23,777	8	M8	30
1-3/4	1.750		2.953		3.307	0.984	1.299	0.787	1.614	18,806	1,371	20,381	22,928	8	M8	30
1-7/8	1.875	+0 -0.0018	3.150	-0 +0.0022	3.504	0.945	1.319	0.787	1.614	18,806	1,469	19,106	21,399	8	M8	30
1-15/16	1.938		3.150		3.504	0.945	1.319	0.787	1.614	18,806	1,518	19,106	20,709	8	M8	30
2	2.000		3.150		3.504	0.945	1.319	0.787	1.614	18,806	1,567	19,109	20,062	8	M8	30
2-1/8	2.125		3.346		3.700	0.945	1.319	0.787	1.614	18,806	1,665	17,987	18,882	8	M8	30
2-3/16	2.188		3.346		3.700	0.945	1.319	0.787	1.614	18,806	1,714	17,987	18,342	8	M8	30
2-1/4	2.250		3.543		3.897	0.945	1.319	0.787	1.614	18,806	1,763	16,987	17,833	8	M8	30
2-3/8	2.375		3.543		3.897	0.945	1.319	0.787	1.614	18,806	1,861	16,987	16,894	8	M8	30
2-7/16	2.438		3.740		4.094	0.945	1.319	0.787	1.614	18,806	1,910	16,092	16,461	8	M8	30
2-1/2	2.500		3.740		4.094	0.945	1.319	0.787	1.614	18,806	1,959	16,092	16,049	8	M8	30
2-9/16	2.563		3.740		4.094	0.945	1.319	0.787	1.614	18,806	2,008	16,092	15,658	8	M8	30
2-11/16	2.688	+0 -0.0022	4.331	-0 +0.0025	4.685	1.142	1.575	0.945	1.969	31,017	3,473	19,100	20,520	8	M10	61
2-3/4	2.750		4.331		4.685	1.142	1.575	0.945	1.969	31,017	3,554	19,100	20,053	8	M10	61
2-7/8	2.875		4.528		4.882	1.142	1.575	0.945	1.969	31,017	3,716	18,269	19,182	8	M10	61
2-15/16	2.938		4.528		4.882	1.142	1.575	0.945	1.969	31,017	3,796	18,269	18,773	8	M10	61
3	3.000		4.724		5.078	1.142	1.575	0.945	1.969	31,017	3,877	17,511	18,382	8	M10	61
3-1/4	3.250		4.921		5.275	1.142	1.575	0.945	1.969	31,017	4,200	16,810	16,968	8	M10	61
3-3/8	3.375		4.921		5.275	1.142	1.575	0.945	1.969	38,771	5,452	21,012	20,425	10	M10	61
3-7/16	3.438		5.118		5.470	1.142	1.575	0.945	1.969	38,771	5,553	20,203	20,053	10	M10	61
3-1/2	3.500		5.118		5.470	1.142	1.575	0.945	1.969	38,771	5,654	20,203	19,695	10	M10	61
3-3/4	3.750		5.315		5.669	1.142	1.575	0.945	1.969	38,771	6,058	19,455	18,382	10	M10	61
3-15/16	3.938	+0 -0.0022	5.708	-0 +0.0025	6.603	1.220	1.732	1.024	2.205	45,836	7,520	19,768	18,627	8	M12	107
4	4.000		5.709		6.603	1.220	1.732	1.024	2.205	45,836	7,639	19,766	18,336	8	M12	107

L	= total width (relaxed state)
B	= width of thrust rings (relaxed state)
A	= width to flange
ℓ	= length of contact
T	= locking screw specifications
M _A	= screw tightening torque
D	= outer diameter of shaft locking device
D ₁	= diameter to flange
d	= shaft diameter
F	= maximum transmissible axial force
M _t	= maximum transmissible torque
pH	= pressure on the hub
pS	= pressure on the shaft
T ₁	= tolerance of shaft
T ₂	= tolerance of hub bore

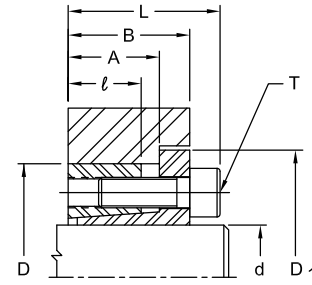

SLD 1750 Metric Series Dimensional Data

Size	d in	T ₁ in	D in	T ₂ in	D ₁ in	A in	B in	ℓ in	L in	Max F lbf	Max M _t ft-lb	Pressures		T Locking Screws		
												pH psi	pS psi	Qty	Size	M _A ft-lb
18x47	0.709	+0 -0.0013	1.850	-0 +0.0015	2.205	0.866	1.102	0.669	1.339	7,242	214	16,328	28,991	6	M6	10
19x47	0.748		1.850		2.205	0.866	1.102	0.669	1.339	7,242	226	16,328	27,465	6	M6	10
20x47	0.787		1.850		2.205	0.866	1.102	0.669	1.339	7,242	238	16,328	26,092	6	M6	10
22x47	0.866		1.850		2.205	0.866	1.102	0.669	1.339	7,242	261	16,328	23,720	6	M6	10
24x50	0.945		1.969		2.323	0.866	1.102	0.669	1.339	7,242	285	15,348	21,743	6	M6	10
25x50	0.984		1.969		2.323	0.866	1.102	0.669	1.339	7,242	297	15,348	20,874	6	M6	10
28x55	1.102		2.165		2.520	0.866	1.102	0.669	1.339	7,242	333	13,953	18,637	6	M6	10
30x55	1.181		2.165		2.520	0.866	1.102	0.669	1.339	7,242	356	13,953	17,395	6	M6	10
32x60	1.260	+0 -0.0015	2.362	-0 +0.0018	2.717	0.866	1.102	0.669	1.339	9,656	507	17,054	21,743	8	M6	10
35x60	1.378		2.362		2.717	0.866	1.102	0.669	1.339	9,656	554	17,054	19,880	8	M6	10
38x65	1.496		2.559		2.913	0.866	1.102	0.669	1.339	9,656	602	15,742	18,310	8	M6	10
40x65	1.575		2.559		2.913	0.866	1.102	0.669	1.339	9,656	634	15,742	17,395	8	M6	10
42x75	1.654		2.953		3.307	0.984	1.299	0.787	1.614	17,866	1,231	21,455	25,542	8	M8	26
45x75	1.772		2.953		3.307	0.984	1.299	0.787	1.614	17,866	1,319	21,455	23,839	8	M8	26
48x80	1.890		3.150		3.504	0.945	1.319	0.787	1.614	17,866	1,407	20,114	22,349	8	M8	26
50x80	1.969		3.150		3.504	0.945	1.319	0.787	1.614	17,866	1,465	20,114	21,455	8	M8	26
55x85	2.165	+0 -0.0018	3.346	-0 +0.0021	3.701	0.945	1.319	0.787	1.614	17,866	1,612	18,931	19,505	8	M8	26
60x90	2.362		3.543		3.898	0.945	1.319	0.787	1.614	17,866	1,758	17,880	17,880	8	M8	26
65x95	2.559		3.740		4.094	0.945	1.319	0.787	1.614	17,866	1,905	16,939	16,504	8	M8	26
70x110	2.756		4.331		4.685	1.142	1.575	0.945	1.969	29,466	3,384	20,106	21,064	8	M10	52
75x115	2.953		4.528		4.882	1.142	1.575	0.945	1.969	29,466	3,625	19,232	19,659	8	M10	52
80x120	3.150		4.724		5.079	1.142	1.575	0.945	1.969	29,466	3,867	18,431	18,431	8	M10	52
85x125	3.347		4.921		5.276	1.142	1.575	0.945	1.969	36,832	5,136	22,117	21,683	10	M10	52
90x130	3.543		5.118		5.472	1.142	1.575	0.945	1.969	36,832	5,438	21,266	20,479	10	M10	52
95x135	3.740	5.315	5.669	1.142	1.575	0.945	1.969	36,832	5,740	20,479	19,401	10	M10	52		
100x145	3.937	+0 -0.0021	5.709	-0 +0.0025	6.063	1.220	1.732	1.024	2.205	43,544	7,143	20,807	19,610	8	M12	85
110x155	4.331		6.102		6.457	1.220	1.732	1.024	2.205	43,544	7,857	19,464	17,827	8	M12	85
120x165	4.724		6.496		6.850	1.220	1.732	1.024	2.205	48,987	9,643	20,570	18,384	9	M12	85
130x180	5.118		7.087		7.441	1.535	2.047	1.339	2.520	65,316	13,929	19,226	18,856	12	M12	85
140x190	5.512		7.480		7.835	1.535	2.126	1.339	2.677	65,743	15,098	18,333	16,919	9	M14	136
150x200	5.906		7.874		8.228	1.535	2.126	1.339	2.677	73,047	17,974	19,351	17,545	10	M14	136
160x210	6.299		8.268		8.622	1.535	2.126	1.339	2.677	87,657	23,007	22,116	19,738	12	M14	136
170x225	6.693		8.858		9.213	1.929	2.520	1.732	3.071	87,657	24,445	15,950	15,481	12	M14	136
180x235	7.087	9.252	9.606	1.929	2.520	1.732	3.071	87,657	25,883	15,271	14,621	12	M14	136		
190x250	7.480	+0 -0.0028	9.843	-0 +0.0032	10.197	1.929	2.520	1.732	3.071	109,571	34,151	17,944	17,314	15	M14	136
200x260	7.874		10.236		10.591	1.929	2.520	1.732	3.071	109,571	35,948	17,254	16,449	15	M14	136

L	= total width (relaxed state)
B	= width of thrust rings (relaxed state)
ℓ	= length of contact
T	= locking screw specifications
M _A	= screw tightening torque
D	= outer diameter of shaft locking device
d	= shaft diameter
F	= maximum transmissible axial force
M _t	= maximum transmissible torque
pH	= pressure on the hub
pS	= pressure on the shaft
T ₁	= tolerance of shaft
T ₂	= tolerance of hub bore

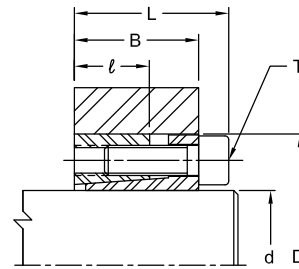
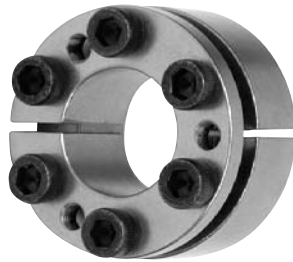

SLD 1350 Inch Series Dimensional Data

Size	d in	T ₁ in	D in	T ₂ in	B in	ℓ in	L in	Max F lbf	Max M _t ft-lb	Pressures		T Locking Screws		
										pH psi	pS psi	Qty	Size	M _A ft-lb
3/4	0.750	+0 -0.0013	1.850	-0 +0.0015	1.102	0.669	1.339	8,733	273	18,710	34,954	6	M6	10
7/8	0.875		1.850		1.102	0.669	1.339	8,659	316	18,710	30,168	6	M6	10
1	1.000	+0 -0.0016	1.969	-0 +0.0018	1.102	0.669	1.339	8,603	358	17,550	26,542	6	M6	10
1-1/8	1.125		2.165		1.102	0.669	1.339	8,874	416	15,954	22,916	6	M6	10
1-3/16	1.188		2.165		1.102	0.669	1.339	8,705	431	15,954	22,191	6	M6	10
1-1/4	1.250		2.362		1.102	0.669	1.339	11,754	612	19,580	27,702	8	M6	10
1-3/8	1.375		2.362		1.102	0.669	1.339	11,689	670	19,580	25,382	8	M6	10
1-7/16	1.438		2.559		1.102	0.669	1.339	11,822	708	18,130	23,931	8	M6	10
1-1/2	1.500		2.559		1.102	0.669	1.339	11,636	727	18,130	23,351	8	M6	10
1-5/8	1.625		2.953		1.299	0.787	1.614	22,211	1,504	25,527	34,519	8	M8	26
1-11/16	1.688		2.953		1.299	0.787	1.614	22,427	1,557	25,527	32,924	8	M8	26
1-3/4	1.750		2.953		1.299	0.787	1.614	22,132	1,614	25,527	32,198	8	M8	26
1-7/8	1.875	+0 -0.0018	3.150	-0 +0.0022	1.319	0.787	1.614	22,535	1,761	23,931	29,588	8	M8	26
1-15/16	1.938		3.150		1.319	0.787	1.614	22,265	1,797	23,931	28,863	8	M8	26
2	2.000		3.150		1.319	0.787	1.614	22,445	1,870	23,931	27,847	8	M8	26
2-1/8	2.125		3.346		1.319	0.787	1.614	22,375	1,981	22,481	26,252	8	M8	26
2-3/16	2.188		3.346		1.319	0.787	1.614	22,537	2,054	22,481	25,237	8	M8	26
2-1/4	2.250		3.543		1.319	0.787	1.614	22,304	2,091	21,321	24,802	8	M8	26
2-3/8	2.375		3.543		1.319	0.787	1.614	22,241	2,201	21,321	23,641	8	M8	26
2-7/16	2.438		3.740		1.319	0.787	1.614	22,389	2,274	20,160	22,916	8	M8	26
2-1/2	2.500		3.740		1.319	0.787	1.614	22,538	2,348	20,160	22,191	8	M8	26
2-9/16	2.563		3.740		1.319	0.787	1.614	22,333	2,385	20,160	21,756	8	M8	26
2-11/16	2.688	+0 -0.0022	4.331	-0 +0.0025	1.575	0.945	1.969	36,292	4,064	23,641	28,282	8	M10	52
2-3/4	2.750		4.331		1.575	0.945	1.969	36,510	4,183	23,641	27,557	8	M10	52
2-7/8	2.875		4.528		1.575	0.945	1.969	36,425	4,363	22,626	26,397	8	M10	52
2-15/16	2.938		4.528		1.575	0.945	1.969	36,626	4,483	22,626	25,672	8	M10	52
3	3.000		4.724		1.575	0.945	1.969	36,341	4,543	21,611	25,382	8	M10	52
3-1/4	3.250		4.921		1.575	0.945	1.969	45,790	6,201	25,962	29,008	10	M10	52
3-3/8	3.375		4.921		1.575	0.945	1.969	45,688	6,425	25,962	27,992	10	M10	52
3-7/16	3.438		5.118		1.575	0.945	1.969	45,378	6,499	24,947	27,702	10	M10	52
3-1/2	3.500		5.118		1.575	0.945	1.969	45,594	6,649	24,947	26,977	10	M10	52
3-3/4	3.750		5.315		1.575	0.945	1.969	45,424	7,098	24,076	25,382	10	M10	52
3-15/16	3.938	5.709	1.732	1.024	2.205	50,625	8,306	22,916	26,687	8	M12	85		
4	4.000	5.709	1.732	1.024	2.205	50,830	8,472	22,916	26,252	8	M12	85		

L	= total width (relaxed state)
B	= width of thrust rings (relaxed state)
ℓ	= length of contact
T	= locking screw specifications
M _A	= screw tightening torque
D	= outer diameter of shaft locking device
d	= shaft diameter
F	= maximum transmissible axial force
M _t	= maximum transmissible torque
pH	= pressure on the hub
pS	= pressure on the shaft
T ₁	= tolerance of shaft
T ₂	= tolerance of hub bore

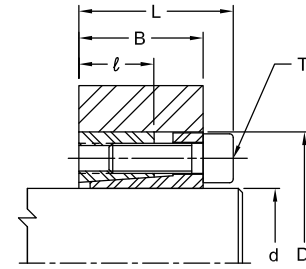

SLD 1350 Metric Series Dimensional Data

Size	d in	T ₁ in	D in	T ₂ in	B in	ℓ in	L in	Max F lbf	Max M _t ft-lb	Pressures		T Locking Screws		
										pH psi	pS psi	Qty	Size	M _A ft-lb
18x47	0.709	+0 -0.0013	1.850	-0 +0.0015	1.102	0.669	1.339	8,780	259	18,710	36,985	6	M6	10
19x47	0.748		1.850		1.102	0.669	1.339	8,790	274	18,710	34,954	6	M6	10
20x47	0.787		1.850		1.102	0.669	1.339	8,308	273	18,710	33,214	6	M6	10
22x47	0.866		1.850		1.102	0.669	1.339	8,310	300	18,710	30,168	6	M6	10
24x50	0.945		1.969		1.102	0.669	1.339	8,311	327	17,550	27,702	6	M6	10
25x50	0.984		1.969		1.102	0.669	1.339	8,304	341	17,550	26,542	6	M6	10
28x55	1.102		2.165		1.102	0.669	1.339	8,314	382	15,954	23,786	6	M6	10
30x55	1.181		2.165		1.102	0.669	1.339	8,315	409	15,954	22,191	6	M6	10
32x60	1.260	+0 -0.0015	2.362	-0 +0.0018	1.102	0.669	1.339	11,079	582	19,580	27,702	8	M6	10
35x60	1.378		2.362		1.102	0.669	1.339	11,081	636	19,580	25,382	8	M6	10
38x65	1.496		2.559		1.102	0.669	1.339	11,083	691	18,130	23,351	8	M6	10
40x65	1.575		2.559		1.102	0.669	1.339	11,074	727	18,130	22,191	8	M6	10
42x75	1.654		2.953		1.299	0.787	1.614	21,245	1,464	25,527	30,748	8	M8	26
45x75	1.772		2.953		1.299	0.787	1.614	21,243	1,568	25,527	31,473	8	M8	26
48x80	1.890		3.150		1.319	0.787	1.614	21,241	1,673	23,931	29,588	8	M8	26
50x80	1.969		3.150		1.319	0.787	1.614	21,246	1,743	23,931	28,282	8	M8	26
55x85	2.165	+0 -0.0018	3.346	-0 +0.0021	1.319	0.787	1.614	21,240	1,916	22,481	25,817	8	M8	26
60x90	2.362		3.543		1.319	0.787	1.614	21,243	2,091	21,321	23,641	8	M8	26
65x95	2.559		3.740		1.319	0.787	1.614	21,245	2,265	20,160	21,756	8	M8	26
70x110	2.756		4.331		1.575	0.945	1.969	34,610	3,974	23,641	27,557	8	M10	52
75x115	2.953		4.528		1.575	0.945	1.969	34,615	4,259	22,626	25,672	8	M10	52
80x120	3.150		4.724		1.575	0.945	1.969	34,614	4,543	21,611	24,076	8	M10	52
85x125	3.346		4.921		1.575	0.945	1.969	43,266	6,033	25,962	28,282	10	M10	52
90x130	3.543		5.118		1.575	0.945	1.969	43,264	6,387	24,947	26,687	10	M10	52
95x135	3.740	5.315	1.575	0.945	1.969	43,267	6,743	24,076	25,382	10	M10	52		
100x145	3.937	+0 -0.0021	5.709	-0 +0.0025	1.732	1.024	2.205	48,100	7,890	22,916	26,687	8	M12	85
110x155	4.331		6.102		1.732	1.024	2.205	48,100	8,679	21,466	21,901	8	M12	85
120x165	4.724		6.496		1.732	1.024	2.205	54,115	10,652	22,771	22,626	9	M12	85
130x180	5.118		7.087		2.047	1.339	2.520	72,150	15,386	21,176	23,206	12	M12	85
140x190	5.512		7.480		2.126	1.339	2.677	73,654	16,915	20,595	21,031	9	M14	136
150x200	5.906		7.874		2.126	1.339	2.677	81,837	20,137	21,611	21,901	10	M14	136
160x210	6.299		8.268		2.126	1.339	2.677	98,204	25,775	24,802	24,511	12	M14	136
170x225	6.693		8.858		2.520	1.732	3.071	98,204	27,386	17,840	19,290	12	M14	136
180x235	7.087	9.252	2.520	1.732	3.071	98,204	28,997	17,114	18,130	12	M14	136		
190x250	7.480	+0 -0.0028	9.843	-0 +0.0032	2.520	1.732	3.071	122,755	38,260	20,160	21,611	15	M14	136
200x260	7.874		10.236		2.520	1.732	3.071	122,755	40,274	19,290	20,450	15	M14	136

Shaft Locking Devices

SLD 1450 Inch Series

Dimensional Data

- L = total width (relaxed state)
- B = width of thrust rings (relaxed state)
- A = width to flange
- ℓ = length of contact
- T = locking screw specifications
- M_A = screw tightening torque
- D = outer diameter of shaft locking device
- D₁ = diameter to flange
- d = shaft diameter
- F = maximum transmissible axial force
- M_t = maximum transmissible torque
- pH = pressure on the hub
- pS = pressure on the shaft
- T₁ = tolerance of shaft
- T₂ = tolerance of hub bore

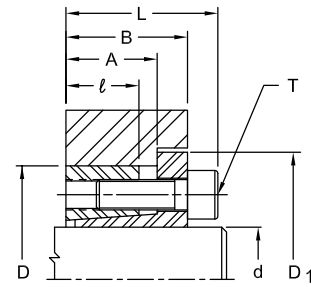

SLD 1450 Inch Series Dimensional Data

Size	d in	T ₁ in	D in	T ₂ in	D ₁ in	A in	B in	ℓ in	L in	Max F lbf	Max M _t ft-lb	Pressures		T		
												pH psi	pS psi	Qty	Locking Screws	
															Size	M _A ft-lb
3/4	0.750	+0 -0.0013	1.850	-0 +0.0015	2.204	0.866	1.102	0.669	1.339	7,242	226	14,739	24,723	6	M6	12
7/8	0.875		1.850		2.204	0.866	1.102	0.669	1.339	7,242	264	14,739	21,191	6	M6	12
1	1.000	+0 -0.0016	1.969	-0 +0.0018	2.323	0.866	1.102	0.669	1.339	7,242	302	13,848	18,542	6	M6	12
1-1/8	1.125		2.165		2.519	0.866	1.102	0.669	1.339	7,242	339	12,595	16,482	6	M6	12
1-3/16	1.188		2.165		2.519	0.866	1.102	0.669	1.339	7,242	358	12,595	15,614	6	M6	12
1-1/4	1.250		2.362		2.716	0.866	1.102	0.669	1.339	9,656	503	15,392	19,778	8	M6	12
1-3/8	1.375		2.362		2.716	0.866	1.102	0.669	1.339	9,656	553	15,392	17,980	8	M6	12
1-7/16	1.438		2.559		2.913	0.866	1.102	0.669	1.339	9,656	578	14,207	17,198	8	M6	12
1-1/2	1.500		2.559		2.913	0.866	1.102	0.669	1.339	9,656	604	14,207	16,482	8	M6	12
1-5/8	1.625		2.953		3.307	0.984	1.299	0.787	1.614	17,866	1,210	19,362	23,457	8	M8	29
1-11/16	1.688		2.953		3.307	0.984	1.299	0.787	1.614	17,866	1,256	19,362	22,588	8	M8	29
1-3/4	1.750		2.953		3.307	0.984	1.299	0.787	1.614	17,866	1,303	19,362	21,781	8	M8	29
1-7/8	1.875	+0 -0.0018	3.150	-0 +0.0022	3.504	0.945	1.319	0.787	1.614	17,866	1,396	18,151	20,329	8	M8	29
1-15/16	1.938		3.150		3.504	0.945	1.319	0.787	1.614	17,866	1,442	18,151	19,673	8	M8	29
2	2.000		3.150		3.504	0.945	1.319	0.787	1.614	17,866	1,489	18,153	19,059	8	M8	29
2-1/8	2.125		3.346		3.700	0.945	1.319	0.787	1.614	17,866	1,582	17,088	17,938	8	M8	29
2-3/16	2.188		3.346		3.700	0.945	1.319	0.787	1.614	17,866	1,628	17,088	17,425	8	M8	29
2-1/4	2.250		3.543		3.897	0.945	1.319	0.787	1.614	17,866	1,675	16,138	16,941	8	M8	29
2-3/8	2.375		3.543		3.897	0.945	1.319	0.787	1.614	17,866	1,768	16,138	16,049	8	M8	29
2-7/16	2.438		3.740		4.094	0.945	1.319	0.787	1.614	17,866	1,814	15,288	15,638	8	M8	29
2-1/2	2.500		3.740		4.094	0.945	1.319	0.787	1.614	17,866	1,861	15,288	15,247	8	M8	29
2-9/16	2.563		3.740		4.094	0.945	1.319	0.787	1.614	17,866	1,908	15,288	14,875	8	M8	29
2-11/16	2.688	+0 -0.0022	4.331	-0 +0.0025	4.685	1.142	1.575	0.945	1.969	29,466	3,300	18,145	19,494	8	M10	58
2-3/4	2.750		4.331		4.685	1.142	1.575	0.945	1.969	29,466	3,376	18,145	19,051	8	M10	58
2-7/8	2.875		4.528		4.882	1.142	1.575	0.945	1.969	29,466	3,530	17,355	18,222	8	M10	58
2-15/16	2.938		4.528		4.882	1.142	1.575	0.945	1.969	29,466	3,607	17,355	17,835	8	M10	58
3	3.000		4.724		5.078	1.142	1.575	0.945	1.969	29,466	3,683	16,635	17,463	8	M10	58
3-1/4	3.250		4.921		5.275	1.142	1.575	0.945	1.969	29,466	3,990	15,969	16,120	8	M10	58
3-3/8	3.375		4.921		5.275	1.142	1.575	0.945	1.969	36,832	5,180	19,962	19,404	10	M10	58
3-7/16	3.438		5.118		5.470	1.142	1.575	0.945	1.969	36,832	5,275	19,193	19,051	10	M10	58
3-1/2	3.500		5.118		5.470	1.142	1.575	0.945	1.969	36,832	5,371	19,193	18,711	10	M10	58
3-3/4	3.750		5.315		5.669	1.142	1.575	0.945	1.969	36,832	5,755	18,482	17,463	10	M10	58
3-15/16	3.938	5.708	6.603	1.220	1.732	1.024	2.205	43,544	7,144	18,780	17,696	8	M12	102		
4	4.000	5.709	6.603	1.220	1.732	1.024	2.205	43,544	7,257	18,778	17,419	8	M12	102		

L	= total width (relaxed state)
B	= width of thrust rings (relaxed state)
A	= width to flange
ℓ	= length of contact
T	= locking screw specifications
M _A	= screw tightening torque
D	= outer diameter of shaft locking device
D ₁	= diameter to flange
d	= shaft diameter
F	= maximum transmissible axial force
M _t	= maximum transmissible torque
p _H	= pressure on the hub
p _S	= pressure on the shaft
T ₁	= tolerance of shaft
T ₂	= tolerance of hub bore

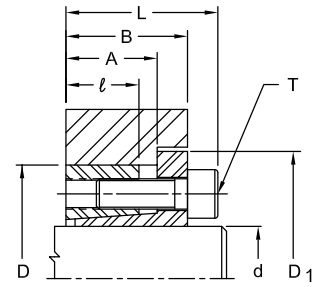

SLD 1450 Metric Series Dimensional Data

Size	d in	T ₁ in	D in	T ₂ in	D ₁ in	A in	B in	ℓ in	L in	Max F lbf	Max M _t ft-lb	Pressures		T Locking Screws				
												p _H psi	p _S psi	Qty	Size	M _A ft-lb		
18x47	0.709	+0 -0.0013	1.850	-0 +0.0015	2.205	0.866	1.102	0.669	1.339	6,880	203	15,512	27,542	6	M6	12		
19x47	0.748		1.850		2.205	0.866	1.102	0.669	1.339	6,880	214	15,512	26,092	6	M6	12		
20x47	0.787		1.850		2.205	0.866	1.102	0.669	1.339	6,880	226	15,512	24,788	6	M6	12		
22x47	0.866		1.850		2.205	0.866	1.102	0.669	1.339	6,880	248	15,512	22,534	6	M6	12		
24x50	0.945		1.969		2.323	0.866	1.102	0.669	1.339	6,880	271	14,581	20,656	6	M6	12		
25x50	0.984		1.969		2.323	0.866	1.102	0.669	1.339	6,880	282	14,581	19,830	6	M6	12		
28x55	1.102	+0 -0.0015	2.165	-0 +0.0018	2.520	0.866	1.102	0.669	1.339	6,880	316	13,255	17,705	6	M6	12		
30x55	1.181		2.165		2.520	0.866	1.102	0.669	1.339	6,880	339	13,255	16,525	6	M6	12		
32x60	1.260		2.362		2.717	0.866	1.102	0.669	1.339	9,173	482	16,201	20,656	8	M8	29		
35x60	1.378		2.362		2.717	0.866	1.102	0.669	1.339	9,173	527	16,201	18,886	8	M8	29		
38x65	1.496		2.559		2.913	0.866	1.102	0.669	1.339	9,173	572	14,955	17,395	8	M8	29		
40x65	1.575		2.559		2.913	0.866	1.102	0.669	1.339	9,173	602	14,955	16,525	8	M8	29		
42x75	1.654	+0 -0.0015	2.953	-0 +0.0018	3.307	0.984	1.299	0.787	1.614	16,972	1,169	20,383	24,265	8	M8	29		
45x75	1.772		2.953		3.307	0.984	1.299	0.787	1.614	16,972	1,253	20,383	22,647	8	M8	29		
48x80	1.890		3.150		3.504	0.945	1.319	0.787	1.614	16,972	1,336	19,109	21,232	8	M8	29		
50x80	1.969		3.150		3.504	0.945	1.319	0.787	1.614	16,972	1,392	19,109	20,383	8	M8	29		
55x85	2.165		+0 -0.0018		3.346	-0 +0.0021	3.701	0.945	1.319	0.787	1.614	16,972	1,531	17,985	18,530	8	M8	29
60x90	2.362				3.543		3.898	0.945	1.319	0.787	1.614	16,972	1,670	16,986	16,986	8	M8	29
65x95	2.559	3.740		4.094	0.945		1.319	0.787	1.614	16,972	1,810	16,092	15,679	8	M8	29		
70x110	2.756	4.331		4.685	1.142		1.575	0.945	1.969	27,993	3,214	19,101	20,010	8	M10	58		
75x115	2.953	4.528		4.882	1.142		1.575	0.945	1.969	27,993	3,444	18,270	18,676	8	M10	58		
80x120	3.150	4.724		5.079	1.142		1.575	0.945	1.969	27,993	3,674	17,509	17,509	8	M10	58		
85x125	3.347	+0 -0.0021	4.921	-0 +0.0025	5.276	1.142	1.575	0.945	1.969	34,991	4,879	21,011	20,599	10	M10	58		
90x130	3.543		5.118		5.472	1.142	1.575	0.945	1.969	34,991	5,166	20,203	19,455	10	M10	58		
95x135	3.740		5.315		5.669	1.142	1.575	0.945	1.969	34,991	5,453	19,455	18,431	10	M10	58		
100x145	3.937		5.709		6.063	1.220	1.732	1.024	2.205	41,367	6,786	19,766	18,630	8	M12	102		
110x155	4.331		6.102		6.457	1.220	1.732	1.024	2.205	41,367	7,464	18,491	16,936	8	M12	102		
120x165	4.724		6.496		6.850	1.220	1.732	1.024	2.205	46,538	9,161	19,542	17,465	9	M12	102		
130x180	5.118	+0 -0.0025	7.087	-0 +0.0028	7.441	1.535	2.047	1.339	2.205	62,050	13,232	18,264	17,913	12	M12	102		
140x190	5.512		7.480		7.835	1.535	2.126	1.339	2.677	62,455	14,343	17,416	16,073	9	M14	161		
150x200	5.906		7.874		8.228	1.535	2.126	1.339	2.677	69,395	17,076	18,384	16,668	10	M14	161		
160x210	6.299		8.268		8.622	1.535	2.126	1.339	2.677	83,274	21,857	21,010	18,751	12	M14	161		
170x225	6.693		8.858		9.213	1.929	2.520	1.732	3.071	87,657	24,445	15,153	14,707	12	M14	161		
180x235	7.087		9.252		9.606	1.929	2.520	1.732	3.071	83,274	24,589	14,508	13,890	12	M14	161		
190x250	7.480	+0 -0.0028	9.843	-0 +0.0032	10.197	1.929	2.520	1.732	3.071	104,092	32,443	17,047	16,449	15	M14	161		
200x260	7.874		10.236		10.591	1.929	2.520	1.732	3.071	104,092	34,151	16,391	15,626	15	M14	161		



Shaft Locking Devices

SLD 2600 Inch Series

Dimensional Data

- L = total width (relaxed state)
- B = width of thrust rings (relaxed state)
- ℓ = length of contact
- T = locking screw specifications
- M_A = screw tightening torque
- D = outer diameter of shaft locking device
- d = shaft diameter
- F = maximum transmissible axial force
- Mt = maximum transmissible torque
- pH = pressure on the hub
- pS = pressure on the shaft
- T₁ = tolerance of shaft
- T₂ = tolerance of hub bore

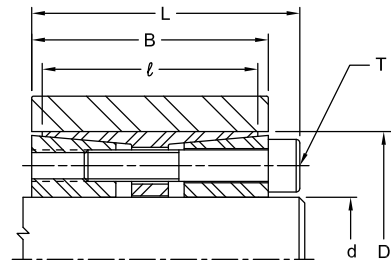

SLD 2600 Inch Series Dimensional Data

Size	d in	T ₁ in	D in	T ₂ in	B in	ℓ in	L in	Max F lbf	Max Mt ft-lb	Pressures		T Locking Screws				
										pH psi	pS psi	Qty	Size	M _A ft-lb		
1	1.000	+0 -0.0013	1.969	-0 +0.0018	1.772	1.614	2.008	12,965	540	12,022	24,886	6	M6	12.5		
1-1/8	1.125		2.165		1.772	1.614	2.008	19,447	810	14,579	29,495	8	M6	12.5		
1-3/16	1.188		2.165		1.772	1.614	2.008	18,247	855	14,579	27,942	8	M6	12.5		
1-1/4	1.250		2.362		1.772	1.614	2.008	18,196	900	13,363	26,545	8	M6	12.5		
1-3/8	1.375		2.362		1.772	1.614	2.008	19,015	990	13,363	24,132	8	M6	12.5		
1-7/16	1.438		2.362		1.772	1.614	2.008	18,072	1,035	13,363	23,083	8	M6	12.5		
1-1/2	1.500		2.559		1.772	1.614	2.008	22,547	1,350	15,418	27,651	10	M6	12.5		
1-5/8	1.625		2.559		1.772	1.614	2.008	23,408	1,463	15,418	25,524	10	M6	12.5		
1-3/4	1.750		2.953		1.772	1.614	2.008	34,443	2,332	19,775	35,081	8	M8	30.2		
1-7/8	1.875		3.150		2.520	2.205	2.835	34,267	2,499	13,573	27,760	8	M8	30.2		
1-15/16	1.938		3.150		2.520	2.205	2.835	33,049	2,582	13,573	26,864	8	M8	30.2		
2	2.000		+0 -0.0015		3.150	-0 +0.0021	2.520	2.205	2.835	33,014	2,665	13,573	26,025	8	M8	30.2
2-1/8	2.125				3.346		2.520	2.205	2.835	33,981	2,832	12,778	24,494	8	M8	30.2
2-3/16	2.188				3.346		2.520	2.205	2.835	32,923	2,915	12,778	23,794	8	M8	30.2
2-1/4	2.250				3.543		2.520	2.205	2.835	41,120	3,748	15,084	28,916	10	M8	30.2
2-3/8	2.375				3.543		2.520	2.205	2.835	42,199	3,956	15,084	27,394	10	M8	30.2
2-7/16	2.438	3.740		2.520	2.205		2.835	41,030	4,060	14,290	26,692	10	M8	30.2		
2-1/2	2.500	3.740		2.520	2.205		2.835	41,003	4,164	14,290	26,025	10	M8	30.2		
2-9/16	2.563	3.740		2.520	2.205		2.835	40,978	4,268	14,290	25,390	10	M8	30.2		
2-5/8	2.625	4.331		3.071	2.756		3.465	67,545	7,212	16,282	33,579	10	M10	61.2		
2-11/16	2.688	4.331		3.071	2.756		3.465	67,507	7,384	16,282	32,798	10	M10	61.2		
2-3/4	2.750	4.331		3.071	2.756		3.465	67,470	7,555	16,282	32,053	10	M10	61.2		
2-7/8	2.875	4.331		3.071	2.756		3.465	68,934	7,899	16,282	30,659	10	M10	61.2		
2-15/16	2.938	4.724		3.071	2.756		3.465	80,844	9,684	17,913	36,008	12	M10	61.2		
3	3.000	4.724		3.071	2.756		3.465	80,808	9,891	17,913	35,258	12	M10	61.2		
3-1/8	3.125	4.724		3.071	2.756		3.465	82,421	10,303	17,913	33,848	12	M10	61.2		
3-1/4	3.250	+0 -0.0021		4.724	-0 0.0025		3.071	2.756	3.465	82,289	10,715	17,913	32,546	12	M10	61.2
3-3/8	3.375		5.118	3.071		2.756	3.465	82,167	11,127	16,534	31,341	12	M10	61.2		
3-7/16	3.438		5.118	3.071		2.756	3.465	80,589	11,333	16,534	30,771	12	M10	61.2		
3-1/2	3.500		5.118	3.071		2.756	3.465	80,563	11,539	16,534	30,221	12	M10	61.2		
3-5/8	3.625		5.118	3.071		2.756	3.465	81,950	11,951	16,534	29,179	12	M10	61.2		
3-3/4	3.750		5.709	3.937		3.543	4.409	120,959	18,270	17,036	33,346	12	M12	106.9		
3-7/8	3.875		5.709	3.937		3.543	4.409	120,824	18,879	17,036	32,270	12	M12	106.9		
3-15/16	3.938		5.709	3.937		3.543	4.409	118,813	19,183	17,036	31,758	12	M12	106.9		
4	4.000		5.709	3.937		3.543	4.409	118,783	19,488	17,036	31,262	12	M12	106.9		
4-1/4	4.250		6.102	3.937		3.543	4.409	124,235	20,706	15,939	29,423	12	M12	106.9		
4-3/8	4.375		6.102	3.937		3.543	4.409	120,366	21,315	15,939	28,582	12	M12	106.9		
4-7/16	4.438		6.496	3.937		3.543	4.409	138,363	25,223	17,468	32,876	14	M12	106.9		
4-1/2	4.500		6.496	3.937		3.543	4.409	138,336	25,578	17,468	32,420	14	M12	106.9		
4-3/4	4.750		6.496	3.937		3.543	4.409	143,993	26,999	17,468	30,714	14	M12	106.9		
4-15/16	4.938		7.087	4.567		4.094	5.118	163,115	32,283	15,938	29,015	12	M14	169.6		
5	5.000		7.087	4.567		4.094	5.118	158,907	32,692	15,938	28,652	12	M14	169.6		
5-1/4	5.250	+0 -0.0025	7.480	-0 +0.0028	4.567	4.094	5.118	192,228	40,048	17,618	31,836	14	M14	169.6		
5-7/16	5.438		7.480		4.567	4.094	5.118	189,613	41,478	17,618	30,738	14	M14	169.6		
5-1/2	5.500		7.480		4.567	4.094	5.118	185,179	41,955	17,618	30,389	14	M14	169.6		
5-3/4	5.750		7.874		4.567	4.094	5.118	218,739	50,128	19,127	33,220	16	M14	169.6		
5-15/16	5.938		7.874		4.567	4.094	5.118	216,051	51,762	19,127	32,171	16	M14	169.6		
6	6.000		8.268		4.567	4.094	5.118	211,431	52,307	18,216	31,836	16	M14	169.6		
6-7/16	6.438		8.858		5.748	5.276	6.378	308,120	77,030	18,112	32,112	16	M16	261.8		
6-1/2	6.500		8.858		5.748	5.276	6.378	289,968	77,778	18,112	31,803	16	M16	261.8		

SLD

L	= total width (relaxed state)
B	= width of thrust rings (relaxed state)
ℓ	= length of contact
T	= locking screw specifications
M _A	= screw tightening torque
D	= outer diameter of shaft locking device
d	= shaft diameter
F	= maximum transmissible axial force
M _t	= maximum transmissible torque
pH	= pressure on the hub
pS	= pressure on the shaft
T ₁	= tolerance of shaft
T ₂	= tolerance of hub bore

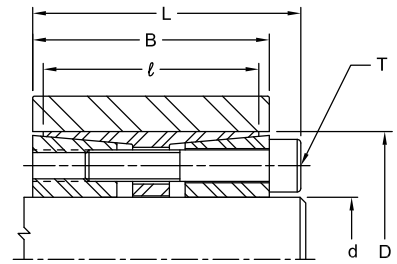

SLD 2600 Metric Series Dimensional Data

Size	d in	T ₁ in	D in	T ₂ in	B in	ℓ in	L in	Max F lbf	Max M _t ft-lb	Pressures		T Locking Screws		
										pH psi	pS psi	Qty	Size	M _A ft-lb
25x50	0.984	+0 -0.0013	1.969	-0 +0.0018	1.772	1.614	2.008	12,965	532	12,026	25,284	6	M6	12.5
30x55	1.181		2.165		1.772	1.614	2.008	20,744	851	14,576	28,094	8	M6	12.5
32x60	1.260		2.362		1.772	1.614	2.008	18,439	907	13,362	26,338	8	M6	12.5
35x60	1.378	+0 -0.0015	2.362	-0 +0.0018	1.772	1.614	2.008	18,907	992	13,362	24,080	8	M6	12.5
40x65	1.575		2.559		1.772	1.614	2.008	24,695	1,418	16,702	26,338	10	M6	12.5
45x75	1.772		2.953		1.772	1.614	2.008	35,980	2,361	19,777	34,652	8	M8	30.2
50x80	1.969	+0 -0.0018	3.150	-0 +0.0021	2.520	2.283	2.835	35,536	2,623	13,107	26,441	8	M8	30.2
55x85	2.165		3.346		2.520	2.283	2.835	35,181	2,886	12,336	24,037	8	M8	30.2
60x90	2.362		3.543		2.520	2.283	2.835	43,612	3,935	14,563	27,543	10	M8	30.2
65x95	2.559	+0 -0.0021	3.740	-0 +0.0025	2.520	2.283	2.835	43,310	4,263	13,796	25,424	10	M8	30.2
70x110	2.756		4.331		3.071	2.756	3.465	71,009	7,571	16,283	31,984	10	M10	61.2
75x115	2.953		4.528		3.071	2.756	3.465	70,646	8,112	15,575	29,852	10	M10	61.2
80x120	3.150	+0 -0.0021	4.724	-0 +0.0025	3.071	2.756	3.465	84,399	10,384	17,911	33,583	12	M10	61.2
85x125	3.346		4.921		3.071	2.756	3.465	84,069	11,033	17,195	31,608	12	M10	61.2
90x130	3.543		5.118		3.071	2.756	3.465	83,778	11,682	16,533	29,852	12	M10	61.2
95x135	3.740	+0 -0.0025	5.315	-0 +0.0028	3.071	2.756	3.465	83,520	12,331	15,804	28,281	12	M10	61.2
100x145	3.937		5.709		3.937	3.622	4.409	123,081	19,181	16,667	31,762	12	M12	106.9
110x155	4.331		6.102		3.937	3.622	4.409	128,620	21,099	15,592	28,875	12	M12	106.9
120x165	4.724	+0 -0.0025	6.496	-0 +0.0032	3.937	3.622	4.409	148,816	26,853	17,088	30,880	14	M12	106.9
130x180	5.118		7.087		4.567	4.252	5.118	169,998	33,464	15,349	27,991	12	M14	169.6
140x190	5.512		7.480		4.567	4.252	5.118	197,157	42,045	16,965	30,324	14	M14	169.6
150x200	5.906	+0 -0.0028	7.874	-0 +0.0032	4.567	4.252	5.118	224,173	51,483	18,419	32,345	16	M14	169.6
160x210	6.299		8.268		4.567	4.252	5.118	223,177	54,916	17,542	30,324	16	M14	169.6
170x225	6.693		8.858		5.748	5.354	6.378	266,987	70,075	15,615	27,026	14	M16	261.8
180x235	7.087	+0 -0.0028	9.252	-0 +0.0032	5.748	5.354	6.378	304,072	84,797	17,086	29,170	16	M16	261.8
190x250	7.480		9.843		5.748	5.354	6.378	303,134	89,508	16,061	27,635	16	M16	261.8
200x260	7.874		10.236		5.748	5.354	6.378	302,294	94,219	15,443	26,253	16	M16	261.8
220x285	8.661	+0 -0.0028	11.220	-0 +0.0032	5.748	5.354	6.378	394,872	129,551	17,611	29,833	20	M16	261.8
240x305	9.449		12.008		5.748	5.354	6.378	430,769	155,461	18,101	30,082	22	M16	261.8

Shaft Locking Devices

SLD 1900 Inch Series

Dimensional Data

- L = total width (relaxed state)
- B = width of thrust rings (relaxed state)
- ℓ = length of contact
- T = locking screw specifications
- M_A = screw tightening torque
- D = outer diameter of shaft locking device
- D₁ = diameter to flange
- d = shaft diameter
- F = maximum transmissible axial force
- Mt = maximum transmissible torque
- pH = pressure on the hub
- pS = pressure on the shaft
- T₁ = tolerance of shaft
- T₂ = tolerance of hub bore

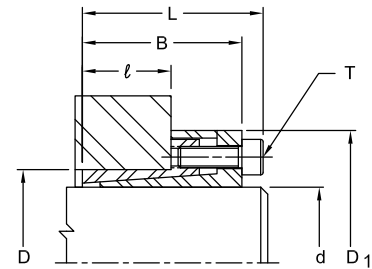

SLD 1900 Inch Series Dimensional Data

Size	d in	T ₁ in	D in	T ₂ in	D ₁ in	B in	ℓ in	L in	Max F lbf	Max Mt ft-lb	Pressures		T Locking Screws		
											pH psi	pS psi	Qty	Size	M _A ft-lb
3/4	0.750	+0 -0.0013	1.063	-0 +0.0015	1.890	1.496	0.709	1.732	5,568	174	11,592	8,966	4	M6	12
7/8	0.875		1.260		2.126	1.772	0.984	2.008	6,496	203	7,419	6,675	4	M6	12
1-5/16	0.938		1.339		2.205	1.772	0.984	2.008	5,952	217	7,154	6,385	4	M6	12
1	1.000		1.339		2.205	1.772	0.984	2.008	5,939	232	7,154	5,985	4	M6	12
1-1/8	1.125	+0 -0.0016	1.535		2.402	1.772	0.984	2.008	9,384	391	9,851	8,399	6	M6	12
1-3/16	1.188		1.614		2.441	1.772	0.984	2.008	8,811	413	9,692	8,231	6	M6	12
1-1/4	1.250		1.693		2.559	1.772	0.984	2.008	11,702	579	12,327	11,129	8	M6	12
1-3/8	1.375		1.850		2.717	1.969	1.181	2.205	12,230	637	9,677	8,679	8	M6	12
1-7/16	1.438		1.969		2.835	1.969	1.181	2.205	11,625	666	9,274	8,468	8	M6	12
1-1/2	1.500		1.969		2.835	1.969	1.181	2.205	11,603	695	9,274	8,115	8	M6	12
1-5/8	1.625		2.165	3.071	2.244	1.260	2.480	12,048	753	8,025	5,800	8	M6	12	
1-11/16	1.688		2.323	3.346	2.559	1.575	2.874	18,447	1,249	9,414	8,787	8	M8	30	
1-3/4	1.750		2.323	3.346	2.559	1.575	2.874	18,432	1,296	9,414	8,473	8	M8	30	
1-7/8	1.875		2.441	3.425	2.756	1.772	3.071	19,035	1,388	8,176	8,120	8	M8	30	
1-15/16	1.938	-0 +0.0018	2.559	3.622	2.756	1.772	3.071	22,950	1,793	9,664	8,976	10	M8	30	
2	2.000		2.795	3.858	2.953	1.969	3.071	22,929	1,851	8,165	8,917	10	M8	30	
2-1/8	2.125		2.795	3.858	2.953	1.969	3.268	23,604	1,967	8,165	8,392	10	M8	30	
2-3/16	2.188		3.031	4.094	2.953	1.969	3.268	22,859	2,024	7,694	8,331	10	M8	30	
2-3/8	2.375		3.031	4.094	2.953	1.969	3.268	24,115	2,198	7,694	7,673	10	M8	30	
2-7/16	2.438		3.307	4.370	2.953	1.969	3.268	22,797	2,256	7,209	7,643	10	M8	30	
2-1/2	2.500		3.307	4.370	2.953	1.969	3.268	22,784	2,314	7,209	7,452	10	M8	30	
2-5/8	2.625		3.543	4.685	3.583	2.362	3.976	37,997	3,958	9,131	10,716	10	M10	60	
2-3/4	2.750		-0 +0.0021	3.543	4.685	3.583	2.362	3.976	37,915	4,147	9,131	10,229	10	M10	60
2-7/8	2.875			3.740	4.961	3.583	2.362	3.976	37,833	4,335	8,623	8,012	10	M10	60
2-15/16	2.938	3.740		4.961	3.583	2.362	3.976	36,981	4,430	8,623	7,841	10	M10	60	
3	3.000	3.740		4.961	3.583	2.362	3.976	36,962	4,524	8,623	7,247	10	M10	60	

L	= total width (relaxed state)
B	= width of thrust rings (relaxed state)
ℓ	= length of contact
T	= locking screw specifications
M _A	= screw tightening torque
D	= outer diameter of shaft locking device
D ₁	= diameter to flange
d	= shaft diameter
F	= maximum transmissible axial force
Mt	= maximum transmissible torque
pH	= pressure on the hub
pS	= pressure on the shaft
T ₁	= tolerance of shaft
T ₂	= tolerance of hub bore

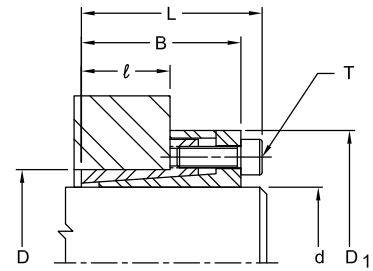

SLD 1900 Metric Series Dimensional Data

Size	d in	T ₁ in	D in	T ₂ in	D ₁ in	B in	ℓ in	L in	Max F lbf	Max Mt ft-lb	Pressures		T Locking Screws		
											pH psi	pS psi	Qty	Size	M _A ft-lb
6x14	0.236	+0 -0.0009	0.591	-0 +0.0011	0.984	0.846	0.354	0.965	1,049	10	13,779	14,939	4	M3	1.50
8x15	0.315		0.591		1.063	0.984	0.472	1.142	2,098	21	14,649	15,084	3	M4	3.70
9x16	0.354		0.630		1.102	0.984	0.551	1.220	2,304	30	15,664	17,840	4	M4	3.70
10x16	0.394		0.630		1.142	1.024	0.551	1.181	2,298	34	15,664	15,954	4	M4	3.70
11x18	0.433	+0 -0.0011	0.709	-0 +0.0013	1.260	1.024	0.551	1.181	2,248	37	13,924	14,504	4	M4	3.70
12x18	0.472		0.709		1.260	1.024	0.551	1.181	2,248	41	13,924	12,763	4	M4	3.70
14x23	0.551		0.906		1.496	1.024	0.551	1.181	2,398	47	10,878	10,878	4	M4	3.70
15x24	0.591		0.945		1.732	1.417	0.630	1.654	4,593	105	19,145	14,794	4	M6	11.1
16x24	0.630	+0 -0.0013	0.945	-0 +0.0015	1.732	1.417	0.630	1.654	4,556	112	19,145	13,924	4	M6	11.1
17x25	0.669		0.984		1.772	1.417	0.630	1.654	4,552	119	18,275	13,053	4	M6	11.1
18x26	0.709		1.024		1.850	1.496	0.709	1.732	5,422	151	18,710	14,794	4	M6	12.5
19x27	0.748		1.063		1.890	1.496	0.709	1.732	5,420	160	18,130	14,069	4	M6	12.5
20x28	0.787	+0 -0.0013	1.102	-0 +0.0018	1.929	1.496	0.709	1.732	5,395	168	17,405	13,343	4	M6	12.5
22x32	0.866		1.260		2.126	1.772	0.984	2.008	5,643	185	11,023	10,008	4	M6	12.5
24x34	0.945		1.339		2.205	1.772	0.984	2.008	5,600	202	10,298	9,137	4	M6	12.5
25x34	0.984		1.339		2.205	1.772	0.984	2.008	5,339	210	10,298	8,847	4	M6	12.5
28x39	1.102	+0 -0.0015	1.535	-0 +0.0021	2.402	1.772	0.984	2.008	8,615	353	13,489	11,748	6	M6	12.5
30x41	1.181		1.614		2.441	1.772	0.984	2.008	8,238	378	12,908	11,023	6	M6	12.5
32x43	1.260		1.693		2.559	1.772	0.984	2.205	10,941	538	16,389	12,183	8	M6	12.5
35x47	1.378		1.850		2.717	1.969	1.181	2.205	11,212	589	12,473	11,168	8	M6	12.5
38x50	1.496	+0 -0.0015	1.969	-0 +0.0025	2.835	1.969	1.181	2.205	11,125	639	11,748	10,298	8	M6	12.5
40x53	1.575		2.087		2.953	1.969	1.181	2.205	10,791	673	11,023	9,718	8	M6	12.5
42x55	1.654		2.165		3.071	2.244	1.260	2.480	19,727	1,294	18,275	12,908	8	M8	30.2
45x59	1.772		2.323		3.346	2.559	1.575	2.874	20,126	1,387	13,634	12,183	8	M8	30.2
48x62	1.890	+0 -0.0018	2.441	-0 +0.0021	3.425	2.756	1.772	3.071	20,033	1,479	11,458	10,443	8	M8	30.2
50x65	1.969		2.559		3.622	2.756	1.772	3.071	24,457	1,926	13,779	12,618	10	M8	30.2
55x71	2.165		2.795		3.858	2.953	1.969	3.268	25,826	2,118	11,313	10,588	10	M8	30.2
60x77	2.362		3.031		4.094	2.953	1.969	3.268	25,612	2,311	10,443	9,718	10	M8	30.2
65x84	2.559	+0 -0.0018	3.307	-0 +0.0021	4.370	2.953	1.969	3.268	25,433	2,503	9,573	8,992	10	M8	30.2
70x90	2.756		3.543		4.685	3.583	2.362	3.976	40,244	4,291	11,893	13,198	10	M10	61.2
75x95	2.953		3.740		4.961	3.583	2.362	3.976	40,035	4,597	11,168	10,153	10	M10	61.2
80x100	3.150		3.937		5.157	3.780	2.559	4.173	47,827	5,884	11,748	10,733	12	M10	61.2
85x106	3.346	+0 -0.0021	4.173	-0 +0.0025	5.394	3.780	2.559	4.173	47,643	6,252	11,168	10,153	15	M10	61.2
90x112	3.543		4.409		5.630	3.780	2.559	4.173	59,350	8,275	13,198	12,038	15	M10	61.2
95x120	3.740		4.724		6.024	3.780	2.559	4.173	59,165	8,735	12,328	11,313	12	M10	61.2
100x125	3.937		4.921		6.378	4.016	2.559	4.488	68,924	10,741	13,779	11,893	12	M12	107
110x140	4.331	+0 -0.0021	5.512	-0 +0.0025	7.087	5.039	3.543	5.512	72,024	11,815	8,847	8,412	12	M12	107
120x155	4.724		6.102		7.795	5.039	3.543	5.512	71,428	12,889	7,977	7,687	12	M12	107
130x165	5.118		6.496		8.189	5.039	3.543	5.512	94,577	18,618	10,008	9,427	16	M12	107

N	= recommended distance to clamp device
D	= outer diameter of shaft locking device
L	= total width (relaxed state)
F _A	= preload force required to generate Mt
d	= shaft diameter
F	= maximum transmissible axial force
Mt	= maximum transmissible torque
pH	= pressure on the hub
pS	= pressure on the shaft
T ₁	= tolerance of shaft
T ₂	= tolerance of hub bore

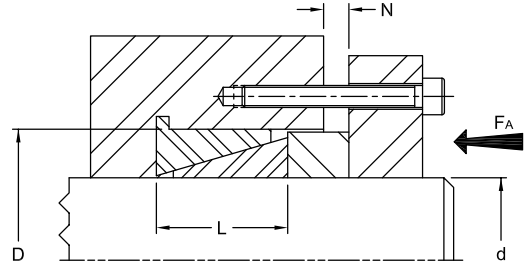

SLD 350 Series Dimensional Data

Size	d in	T ₁ in	D in	T ₂ in	L in	N Distance (in)				Max F lbf	Max Mt ft-lb	Pressures		F _A lb
						Number of Elements						pH psi	pS psi	
						1	2	3	4					
6x9	0.236	+0 -0.0003	0.354	-0 +0.0006	0.177	0.118	0.118	0.118	0.157	176	1.73	10,878	15,954	899
7X10	0.276		0.394		0.177	0.118	0.118	0.118	0.157	220	2.53	12,473	15,594	1,124
8X11	0.315		0.433		0.177	0.118	0.118	0.118	0.157	265	3.47	13,053	15,664	1,349
9X12	0.354	-0 +0.0007	0.472	0.177	0.118	0.118	0.118	0.157	309	4.56	13,053	15,594	1,574	
10x13	0.394		0.512	0.177	0.118	0.118	0.118	0.157	344	5.64	14,504	16,244	1,754	
12x15	0.472		0.591	0.177	0.118	0.118	0.118	0.157	410	8.07	13,053	16,099	2,091	
13x16	0.512	+0 -0.0004	0.630	-0 +0.0008	0.177	0.118	0.118	0.118	0.157	463	9.88	13,053	16,099	2,360
14x18	0.551		0.709		0.248	0.118	0.157	0.157	0.197	683	15.70	13,053	16,099	3,485
15x19	0.591		0.748		0.248	0.118	0.157	0.157	0.197	736	18.10	13,053	16,099	3,754
16x20	0.630	+0 -0.0005	0.787	-0 +0.0010	0.248	0.118	0.157	0.157	0.197	828	21.70	13,053	16,099	4,002
17x21	0.669		0.827		0.248	0.118	0.157	0.157	0.197	816	22.70	13,053	16,099	4,159
18x22	0.709		0.866		0.248	0.118	0.157	0.157	0.197	931	27.50	13,053	16,099	4,496
19x24	0.748	+0 -0.0006	0.945	-0 +0.0012	0.248	0.118	0.157	0.157	0.197	982	30.60	13,053	16,099	4,743
20x25	0.787		0.984		0.248	0.118	0.157	0.157	0.197	1,033	33.90	13,053	16,099	4,991
22x26	0.866		1.024		0.248	0.118	0.157	0.157	0.197	1,135	41.00	13,053	16,099	5,485
24x28	0.945	+0 -0.0015	1.102	-0 +0.0014	0.248	0.118	0.157	0.157	0.197	1,582	62.30	14,504	20,595	7,644
25x30	0.984		1.181		0.248	0.118	0.157	0.157	0.197	1,238	50.80	14,504	15,519	5,980
28x32	1.102		1.260		0.248	0.118	0.157	0.157	0.197	1,447	66.50	14,504	16,099	6,992
30x35	1.181	+0 -0.0018	1.378	-0 +0.0016	0.248	0.118	0.157	0.157	0.197	1,550	76.30	14,504	16,099	7,486
32x36	1.260		1.417		0.248	0.118	0.157	0.157	0.197	1,652	86.70	14,504	16,099	7,981
35x40	1.378		1.575		0.276	0.118	0.157	0.157	0.197	2,048	118.00	14,504	16,099	9,892
36x42	1.417	+0 -0.0021	1.654	-0 +0.0014	0.276	0.118	0.157	0.157	0.197	2,011	119.00	14,504	16,099	10,251
38x44	1.496		1.732		0.276	0.157	0.197	0.197	0.236	2,225	139.00	14,504	16,099	10,746
40x45	1.575		1.772		0.315	0.157	0.197	0.197	0.236	2,574	169.00	14,504	16,099	12,432
42x48	1.654	+0 -0.0025	1.890	-0 +0.0016	0.315	0.157	0.197	0.197	0.236	2,704	186.00	14,504	16,099	13,061
45x52	1.772		2.047		0.394	0.157	0.197	0.197	0.236	3,774	279.00	14,504	16,099	18,232
48x55	1.890		2.165		0.394	0.157	0.197	0.197	0.236	4,026	317.00	14,504	16,099	19,446
50x57	1.969	+0 -0.0018	2.244	-0 +0.0012	0.394	0.157	0.197	0.197	0.236	4,193	344.00	14,504	16,099	20,255
55x62	2.165		0.394		0.394	0.157	0.197	0.197	0.236	4,612	416.00	14,504	16,099	22,279
56x64	2.205		2.520		0.472	0.157	0.197	0.236	0.276	5,048	464.00	14,504	16,099	25,741
60x68	2.362	+0 -0.0021	2.677	-0 +0.0014	0.472	0.157	0.197	0.236	0.276	6,097	600.00	14,504	16,099	29,450
65x73	2.559		2.874		0.472	0.157	0.197	0.236	0.276	6,609	705.00	14,504	16,099	31,923
70x79	2.756		3.110		0.551	0.157	0.197	0.236	0.276	8,331	957.00	14,504	16,099	40,241
75x84	2.953	+0 -0.0025	3.307	-0 +0.0014	0.551	0.157	0.197	0.236	0.276	8,936	1,099.00	14,504	16,099	43,163
80x91	3.150		3.583		0.669	0.197	0.236	0.276	0.315	11,682	1,533.00	14,504	19,870	56,427
85x96	3.346		3.780		0.669	0.197	0.236	0.276	0.315	11,746	1,638.00	14,504	16,099	59,889
90x101	3.543	+0 -0.0021	3.976	-0 +0.0014	0.669	0.197	0.236	0.276	0.315	13,171	1,945.00	14,504	16,099	63,621
95x106	3.740		4.173		0.669	0.197	0.236	0.276	0.315	14,021	2,185.00	14,504	16,099	71,489
100x114	3.937		4.488		0.827	0.197	0.236	0.315	0.354	18,244	2,993.00	13,053	16,099	88,125
110x124	4.331	+0 -0.0025	4.882	-0 +0.0016	0.827	0.197	0.236	0.315	0.354	20,059	3,620.00	13,053	16,099	96,893
120x134	4.724		5.276		0.827	0.197	0.236	0.315	0.354	21,874	4,306.00	13,053	16,099	105,660
130x148	5.118		5.827		1.102	0.236	0.276	0.354	0.433	32,066	6,838.00	13,053	16,099	154,893
140x158	5.512	+0 -0.0025	6.220	-0 +0.0016	1.102	0.236	0.276	0.354	0.433	34,533	7,931.00	13,053	16,099	166,808
150x168	5.906		6.614		1.102	0.236	0.276	0.354	0.433	36,999	9,104.00	13,053	16,099	178,723

Notes: ■ Do not use Molybdenum Disulfide lubricant.

■ Locking devices can be provided with a slit that allows the device to be expanded or contracted to accommodate many inch size shafts.